



TI-*nspire*<sup>™</sup>

**Getting Started with the  
TI-Nspire<sup>™</sup>/  
TI-Nspire<sup>™</sup> CAS Handheld**

This guidebook applies to TI-Nspire<sup>™</sup> software version 3.2. To obtain the latest version of the documentation, go to [education.ti.com/guides](http://education.ti.com/guides).

## ***Important Information***

Except as otherwise expressly stated in the License that accompanies a program, Texas Instruments makes no warranty, either express or implied, including but not limited to any implied warranties of merchantability and fitness for a particular purpose, regarding any programs or book materials and makes such materials available solely on an "as-is" basis. In no event shall Texas Instruments be liable to anyone for special, collateral, incidental, or consequential damages in connection with or arising out of the purchase or use of these materials, and the sole and exclusive liability of Texas Instruments, regardless of the form of action, shall not exceed the amount set forth in the license for the program. Moreover, Texas Instruments shall not be liable for any claim of any kind whatsoever against the use of these materials by any other party.

## **FCC Statement**

Note: This equipment has been tested and found to comply with the limits for a Class B digital device, pursuant to Part 15 of the FCC Rules. These limits are designed to provide reasonable protection against harmful interference in a residential installation. This equipment generates, uses and can radiate radio frequency energy and, if not installed and used in accordance with the instructions, may cause harmful interference to radio communications. However, there is no guarantee that interference will not occur in a particular installation.

If this equipment does cause harmful interference to radio or television reception, which can be determined by turning the equipment off and on, the user is encouraged to try to correct the interference by one or more of the following measures:

- Reorient or relocate the receiving antenna.
- Increase the separation between the equipment and receiver.
- Connect the equipment into an outlet on a circuit different from that to which the receiver is connected.
- Consult the dealer or an experienced radio/TV technician for help.

Modifications not expressly approved by the manufacturer could void the user's authority to operate the equipment under FCC rules.

Vernier DataQuest™ is a trademark of its respective owner.

© 2006 - 2012 Texas Instruments Incorporated

# Contents

Important Information.....	ii
<b>Getting Started with the TI-Nspire™ Handheld .....</b>	<b>1</b>
About CAS.....	1
TI-Nspire™ Handheld Keys .....	2
Preparing the Handheld for Use .....	3
Turning On the TI-Nspire™ Handheld for the First Time .....	3
Using the TI-Nspire™ Touchpad .....	5
Using the Home Screen.....	6
Understanding the Scratchpad.....	9
The TI-Nspire™ Handheld Screen.....	9
Using Hints.....	10
<b>Using the Scratchpad.....</b>	<b>11</b>
Opening and Closing the Scratchpad.....	11
Calculating with the Scratchpad .....	12
Inserting Items from the Catalog .....	13
Viewing the History.....	17
Editing Scratchpad Expressions .....	18
Graphing with the Scratchpad .....	19
Working with Variables in the Scratchpad .....	24
Saving the Scratchpad Contents.....	24
Clearing Scratchpad Contents .....	25
<b>Working with Documents on TI-Nspire™ Handhelds.....</b>	<b>27</b>
Opening a Document.....	27
Creating a New Document .....	28
Saving Documents .....	29
Working with Applications.....	30
Using the Application Menu.....	35
Context Menus .....	37
Working with Problems and Pages .....	37
Adding a Problem to a Document .....	37
Viewing and Reordering Pages in a Document.....	38
Copying, Pasting, and Deleting Problems.....	41
Renaming a Problem.....	42
Adding a Page to a Problem.....	42
Moving Through Pages in a Document .....	43
Managing Documents.....	43
Closing a Document .....	47

Understanding the TI-Nspire™ Tools.....	47
<b>Working with Images .....</b>	<b>53</b>
Working with Images on a Handheld .....	53
<b>Working in a TI-Nspire™ Navigator™ Teacher Software Classroom .....</b>	<b>57</b>
Logging In .....	57
Pausing a Class Session .....	58
Understanding File Transfers .....	58
<b>Configuring Handhelds .....</b>	<b>61</b>
Installing the AAA Batteries.....	61
Replacing AAA Batteries .....	63
Inserting the TI-Nspire™ Rechargeable Battery .....	63
Checking Battery Status .....	65
Recharging the Handheld .....	65
Changing Handheld Settings .....	66
Changing the Preferred Language .....	67
Customizing the Handheld Setup.....	68
Customizing Document Settings.....	69
Customizing Graphs & Geometry Settings.....	73
Viewing Handheld Status.....	75
Using Wireless Communication Hardware.....	76
<b>Connecting Handhelds and Transferring Files.....</b>	<b>79</b>
Connecting Handhelds .....	79
Transferring Files to and from Handhelds.....	80
Transferring Files Between Computers and Handhelds .....	82
Handling Errors Resulting from Sending Folders.....	84
<b>Memory and File Management .....</b>	<b>89</b>
Checking Available Memory .....	89
Freeing Memory.....	90
Resetting the Memory.....	92
<b>Updating the Handheld Operating System.....</b>	<b>95</b>
What You Need to Know .....	95
Finding Operating System Updates.....	96
Updating the Operating System .....	97
Updating the OS on Multiple Handhelds.....	101

OS Upgrade Messages ..... 102

**Using Keyboard Shortcuts ..... 107**

    Keyboard Shortcuts ..... 107

**Working in TI-84 Mode ..... 111**

    Understanding Dual-Mode Operation ..... 111

    TI-84 Plus Mode Cables ..... 113

    Capturing Screens in TI-84 Mode ..... 113

    Upgrading the TI-84 Plus OS ..... 114

**Appendix: Service and Support ..... 115**

    Battery Precautions ..... 115

    Texas Instruments Support and Service ..... 116

    Service and Warranty Information ..... 116

**Index ..... 117**



# Getting Started with the TI-Nspire™ Handheld

The TI-Nspire™ handheld and the TI-Nspire™ CAS handheld are the second generation handhelds in the TI-Nspire™ family of products. These handhelds provide touchpad navigation, dynamic graphing, and interactive computer features.

The handheld and the TI-Nspire™ software share the same functionality, enabling you to transfer class assignments from the handheld to the computer or transfer documents to the handheld when you need to be mobile. Start assignments at school, and then finish the work at home to take advantage of the software's full-color display and easy-to-use navigation. Use the software to download the latest software and handheld operating system updates as they become available to ensure you have the latest enhancements.

This guide covers both the TI-Nspire™ handheld and the TI-Nspire™ CAS handheld. While they operate identically in many ways, there are a few distinctions. If the TI-Nspire™ CAS handheld has additional functionality, it is pointed out and the CAS operation is described.

## **About CAS**

With CAS, or the Computer Algebra System, you can:

- Perform both symbolic and numeric calculations.
- Factor and expand expressions and solve for common denominators.

TI-Nspire™ CAS technology makes it possible to recognize, simplify, and calculate math expressions, preserving the symbols including variables and terms such as "e" and  $\pi$ .

This ability to enter and view equations and expressions on screen as they appear in textbooks is especially useful for step-by-step, arithmetic, algebraic, and calculus calculations.

# TI-Nspire™ Handheld Keys

**esc** Removes menus or dialog boxes from the screen. Also stops a calculation in progress.

**Scratchpad** Opens the Scratchpad for performing quick calculations and graphing.

**tab** Moves to the next entry field.

**ctrl** Provides access to the function or character shown above each key. Also enables shortcuts in combination with other keys.

**⇧ shift** Makes the next character typed upper-case.

Use the **TI-Nspire™ Touchpad** as you would a laptop touchpad. You can also press the outer edges to move right, left, up, and down.

**on** Turns on the handheld. If the handheld is on, this key displays the home screen.

**doc ▾** Opens the Document menu.

**menu** Displays the application or context menu.

**del** Deletes the previous character.

**var** Displays stored variables.

**enter** Evaluates an expression, executes an instruction, or selects a menu item.

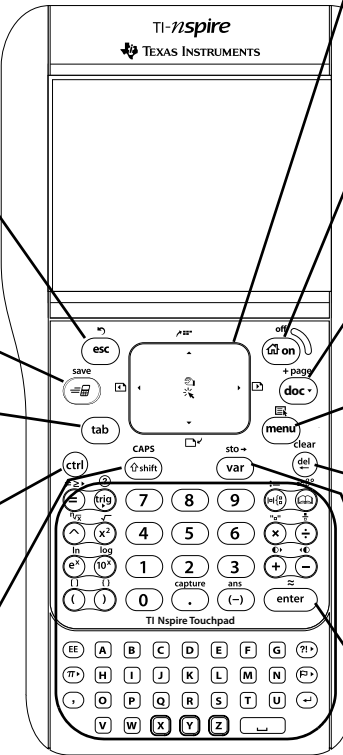

**Note:** A **▶** symbol on a key indicates access to multiple options. To access an option, press **▶** repeatedly or use the arrow keys on the Touchpad. Press **enter** or click to select the option.



## Preparing the Handheld for Use

TI-Nspire™ handhelds are shipped with four alkaline AAA batteries and a standard A male to mini B male USB cable. Handhelds can also be powered using the TI-Nspire™ Rechargeable Battery or an approved wall charger, which are sold separately.



Before using the handheld, either install the AAA batteries **or** install and charge the TI-Nspire™ Rechargeable Battery (if purchased). You can also connect your handheld to an external power source if you have the wall charger.

**Note:** For more information about installing batteries, see *Configuring Handhelds*.

## Turning On the TI-Nspire™ Handheld for the First Time





1. Ensure that batteries have been installed or charged, or that the handheld is connected to a power source.
2. Press  to turn on the handheld.

A progress bar displays while the operating system loads, and then you are prompted to choose preferences for language and font size.

To turn the handheld off, press  . The settings and memory contents are retained.

**Note:** For more information about installing and charging batteries, see *Configuring Handhelds*.

## Using Automatic Power Down™



To prolong battery life, the Automatic Power Down™ (APD™) feature turns off the handheld after three minutes of inactivity. When this happens, press  to turn the handheld on and return to the last document or menu accessed. To change the default setting, press    to access the **Handheld Setup** screen where you can change the **Power Standby** setting.

**Note:** For more information about setting up the handheld, see *Configuring Handhelds*.

## Choosing a Language

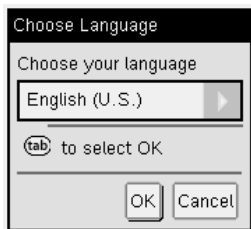
After the OS is loaded, select a preferred language.



1. Press **▶** to open the drop-down list.
2. Press **▼** to scroll through the languages, and then press  or **enter** to select a language.
3. Press **(tab)** to highlight the **OK** button, and then press  or **enter** to save the language selection.

### Choosing a font size

Next, select a font size for the display.

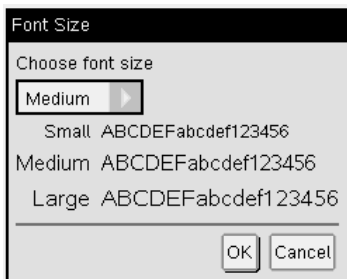

1. Press **▶** to open the drop-down list.
2. Press **▼** to highlight the font size, and then press  or **enter** to select it.

- Press **(tab)** to highlight the **OK** button, and then press  or **(enter)** to save the selection and open the **Welcome!** screen.

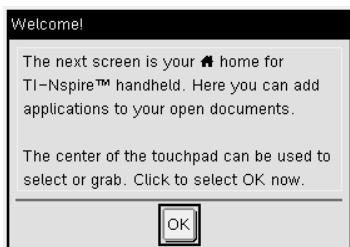

- To continue, click  or press **(enter)** to select **OK** and open the **Home** screen.

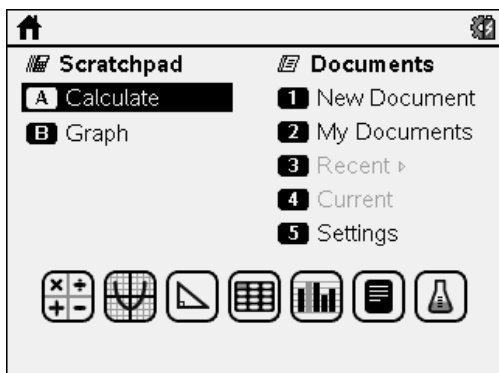



## Using the TI-Nspire™ Touchpad

Use the Touchpad to navigate or complete any task that can be completed using the arrow and Enter keys. Use the Touchpad to navigate in two ways:

- Use it like a computer touchpad by moving your fingertip in a sliding motion on the center area of the Touchpad to activate and move the mouse pointer. Click or tap the center of the Touchpad to select a menu option or complete an action.
- Press the arrow keys on the outside edge of the Touchpad to nudge the mouse pointer up, down, left, or right, and then click  or press **(enter)** to complete an action.

If you hold down an arrow key, the mouse pointer continues to move in that direction.

**Note:** If the mouse pointer is visible on a command or file, click or tap  in the center of the Touchpad to select that command or file. If the command or file is highlighted, move the pointer over that item or press  to select it.

When working in an application, use the Touchpad to access more information about problems. For example, hovering over a Graphs & Geometry object displays information about variables used in that object and about tools that are available.

Some users prefer to customize their Touchpad settings; to speed up or slow down the pointer, or to enable tap to click. To change default settings for the Touchpad see *Configuring Handhelds*.







## ***Using the Home Screen***

The **Home** screen opens when you power on your handheld for the first time. The **Home** screen provides a starting point for all activities performed on a handheld:



- Opening the Scratchpad for quick calculations and graphing
- Creating new documents
- Opening and managing existing documents
- Defining settings and viewing status
- Viewing hints for operating the handheld
- Accessing recent documents
- Returning to the current document



**Note:** To return to the **Home** screen from any other location, press .

## **Selecting Options on the Home Screen**



- By default, the cursor is not active. To activate the cursor, swipe the Touchpad with your fingertip.
- Use the Touchpad to click on any of the application icons or any of the Scratchpad or Documents menu options.
- Press the arrows on the Touchpad (, , , or ) to move among the options on the **Home** screen.
- Move the mouse pointer over each application icon to view a brief description.
- Press  or  to select a highlighted option, or press the number or letter associated with the option.







## Adjusting the Contrast

To lighten the display, press and hold  and tap .

To darken the display, press and hold  and tap .

## Home Screen Options

Menu Option	Purpose
<b>Scratchpad</b> Use the Scratchpad menu options to open a Calculator or Graph application without affecting your document. While in Scratchpad, press  to toggle between Scratchpad applications: Calculate and Graph.	
<b>Calculate</b>	Opens the Scratchpad with a Calculator application active. From the Home screen, press <b>A</b> .
<b>Graph</b>	Opens the Scratchpad with a Graph application active. From the Home screen, press <b>B</b> .
<b>Documents</b> To select options for working with documents, press the associated number or use the Touchpad to select an icon then press  or  .	
<b>New Document</b>	Opens a new TI-Nspire™ document with available applications listed.
<b>My Documents</b>	Opens the file browser where you can open existing TI-Nspire™ documents or send files to others.
<b>Recent</b>	Lists the five most recently saved documents.
<b>Current</b>	Goes to the document that is currently open.
<b>Settings</b>	Check the status of the handheld and change settings.
<b>Application icons</b> To add a new page to the current document, select an application icon. If no document is open, a new document opens with the selected application on a new page.	

Menu Option	Purpose
<b>Calculator</b> 	Adds a page to a document for entering and evaluating math expressions.
<b>Graphs</b> 	Adds a page for graphing and exploring functions.
<b>Geometry</b> 	Adds a page for creating and exploring geometric shapes.
<b>Lists &amp; Spreadsheet</b> 	Adds a page for working with data in tables.
<b>Data &amp; Statistics</b> 	Adds a page and provides tools used to visualize sets of data in different types of plots and provides tools for manipulating data sets to explore relationships between the sets of data.
<b>Notes</b> 	Provides text editing functions for adding text to TI-Nspire™ documents for use as notes or to share with other users.
<b>Vernier DataQuest™</b> 	Adds a page for collecting and analyzing data from sensors or probes.

To learn more about applications and documents, see the *Working with Documents on the TI-Nspire™ Handhelds*.

## Understanding the Scratchpad





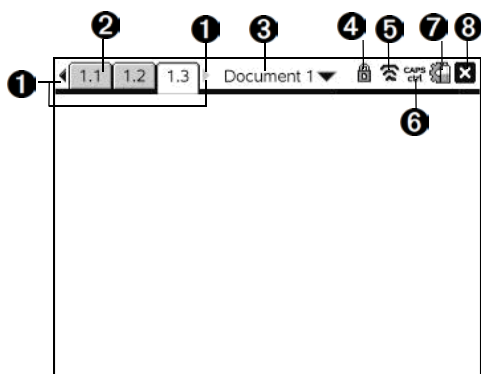

Use the Scratchpad to make quick calculations and graphs without affecting the current TI-Nspire™ document. For example, when you need a quick way to test a calculation before you add it to a document, you can open the Scratchpad application and perform the calculation. Then, you can either discard the calculation or add it to a document. For more information about the Scratchpad, please see *Using the Scratchpad*.

## The TI-Nspire™ Handheld Screen

The icons on the handheld screen provide information about the status of handheld operations and provide an easy way to access and change settings. This screen shows the icons, which are described below.













	Icon	Function
1	◀▶	<b>Page scrolling arrows</b> - Use the Touchpad and these arrows to scroll through the pages in a document.
2	1.1	<b>Page tabs</b> - Indicate the problem number followed by the page number. If problems are named, move the Touchpad pointer over the tab to view the page name.
3		<b>Document name</b> - Shows the current document name. Click here to access the Documents menu. An asterisk by the document name indicates changes were made since the document was last saved.
4	🔒	<b>Press to Test</b> - Indicates that the handheld is in Press-to-Test mode.

	Icon	Function
5		<b>Login status</b> - Shows whether the handheld is searching for an access point (blinking), found an access point (solid), not communicating, connected and ready to log in (a blinking arrow), or logged in and charged (a solid arrow). Click here to view Settings & Status.
6		 ,  , or  status
7		<b>Settings &amp; Status:</b> <ul style="list-style-type: none"> <li>• Hover the cursor over the icon to show the angle mode setting in effect for the active application and the status of the batteries.</li> <li>• Click the icon to open the Settings menu.</li> </ul>
8		<b>Close document</b> - Click here to close the current document. If information is unsaved, save or discard when prompted.

## Using Hints

**Hints** are quick tips available throughout the software on the handheld. There are several easy ways to access Hints:

- Press  .
- Some dialog boxes contain a question mark icon. Click this icon to open Hints for that task.
- ▶ To scroll through the Hints, use the Touchpad or arrow keys:
  - To page down, press  .
  - To page up, press  .
  - To go to the end of the Hints file, press  .
  - To go back to the beginning of the file, press  .



# Using the Scratchpad

The Scratchpad is a feature of the TI-Nspire™ handheld that lets you quickly:

- Evaluate math expressions.
- Graph functions.

## Opening and Closing the Scratchpad

- ▶ From the Home screen, press  $\left(\frac{\text{TI}}{\text{N}}\right)$  to open the Scratchpad.

The first time you open the Scratchpad, a blank page opens with the Calculator active.

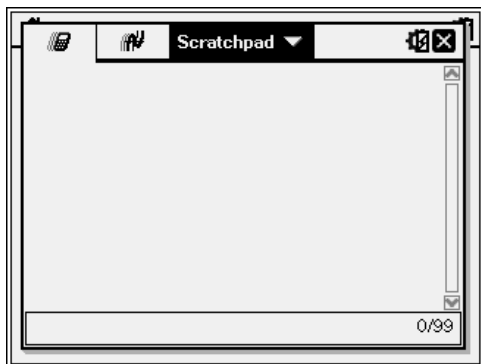

- ▶ Press  $\left(\frac{\text{TI}}{\text{N}}\right)$  to alternate between the Calculate and Graph pages.

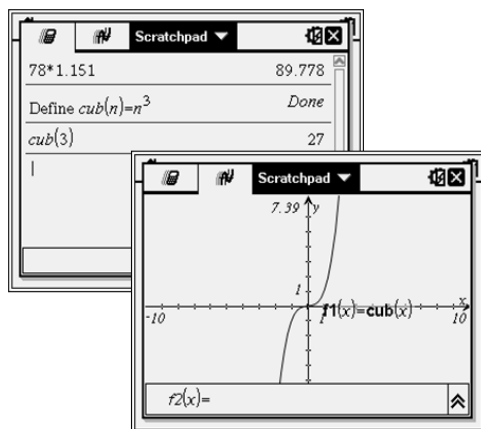

- ▶ Press  $\text{(menu)}$  to see the Scratchpad Calculate or Scratchpad Graph menu. These menus are subsets of the TI-Nspire™ menus for the Calculator and Graphs applications. For complete listings of those menus, see the documentation for those applications.
- ▶ Press  $\text{(esc)}$  to close the Scratchpad.

## Calculating with the Scratchpad

From the Scratchpad Calculate page, type a math expression on the entry line, and then press  $\text{(enter)}$  to evaluate the expression. Expressions are displayed in standard mathematical notation as you enter them.

Each evaluated expression and result becomes part of the Scratchpad history, displayed above the entry line.

### Entering Simple Math Expressions

**Note:** To enter a negative number, press  $\text{(-)}$  and then type the number.

$$\frac{2^8 \cdot 43}{12}$$

Suppose you want to evaluate

1. Select the entry line in the work area.
2. Type  $2 \wedge 8$  to begin the expression.

$$2^8$$

3. Press  $\blacktriangleright$  to return the cursor to the baseline, and then complete the expression by typing:

$$\times 43 \div 12$$

$$2^8 \cdot 43 / 12$$

4. Press  $\text{(enter)}$  to evaluate the expression.

The expression displays in standard mathematical notation, and the result displays on the right side of the page.

$$\frac{2^8 \cdot 43}{12}$$

$$\frac{2752}{3}$$

**Note:** You can force a decimal approximation in a result by pressing  $\text{(ctrl)} \text{(enter)}$  instead of  $\text{(enter)}$ .

$$\frac{2^{8.43}}{12} \qquad 917.333$$

Pressing **(ctrl)** **(enter)** forces the approximate result.

**Note:** Results formatting can also be adjusted in settings. For more information about customizing settings, see *Configuring Handhelds*.

## Inserting Items from the Catalog

You can use the Catalog to insert functions and commands, symbols, and expression templates into the entry line.

1. Press **(☰)** to open the Catalog. By default, the first tab is displayed, which lists all commands and functions in alphabetical order.

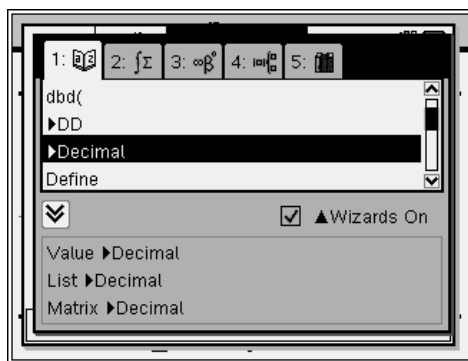

Catalog for a non-CAS handheld

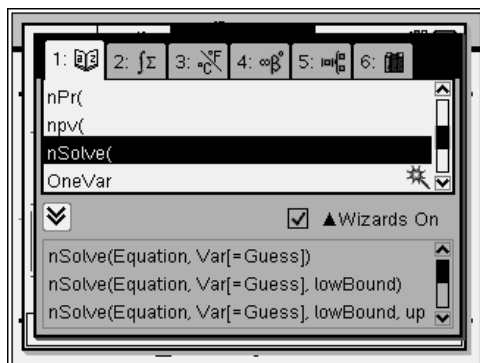

Catalog for a CAS handheld

2. If the function you are inserting is visible in the list, select it and press **enter** to insert it.
3. If the function is not visible:
  - a) Press a letter key to jump to the entries that begin with that letter.
  - b) Press **▼** or **▲** as necessary to highlight the item you are inserting.
  - c) Click a numbered tab to list functions by category: math functions, symbols, math templates, library objects, and value for standard measurement units (CAS).
  - d) Press **enter** to insert the item into the entry line.

## Using an Expression Template

Templates help you enter matrices, piecewise functions, systems of equations, integrals, derivatives, products, and other math expressions.

$$\sum_{n=3}^7 (n)$$

For example, suppose you want to evaluate  $n=3$

1. Press **Ⓜ** to open the Template palette.
2. Select  to insert the algebraic sum template.

The template appears on the entry line with small blocks representing elements that you can enter. A cursor appears next to one of the elements to show that you can type a value for that element.

$$\sum_{n=□}^□ (□)$$

3. Use the arrow keys to move the cursor to each element's position, and type a value or expression for each element.

$$\sum_{n=3}^7 (n)$$

4. Press **enter** to evaluate the expression.

$$\sum_{n=3}^7 (n)$$

## Inserting Expressions Using a Wizard

You can use a wizard to simplify entering some expressions. The wizard contains labeled boxes to help you enter the arguments in the expression.

For example, suppose you want to fit a  $y=mx+b$  linear regression model to the following two lists:

{1,2,3,4,5}

{5,8,11,14,17}

1. Press  $\left(\frac{\text{Ⓜ}}{\text{Ⓜ}}\right)$   $\text{\textcircled{1}}$  to open the Catalog and show the alphabetic list of functions.
2. Click inside the list, and then press  $\left[\text{L}\right]$  to jump to the entries that begin with "L."
3. Press  $\blacktriangledown$  as necessary to highlight **LinRegMx**.
4. If the **Wizards On** option is not checked, press  $\left(\text{tab}\right)$   $\left(\text{tab}\right)$  to highlight **Wizards On**.
5. Press  $\left(\text{enter}\right)$  to change the setting.
6. Press  $\left(\text{tab}\right)$   $\left(\text{tab}\right)$  to highlight **LinRegMx** again.

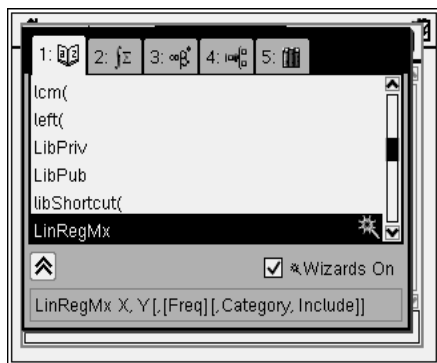

LinRegMx  
function in a  
non-CAS  
handheld

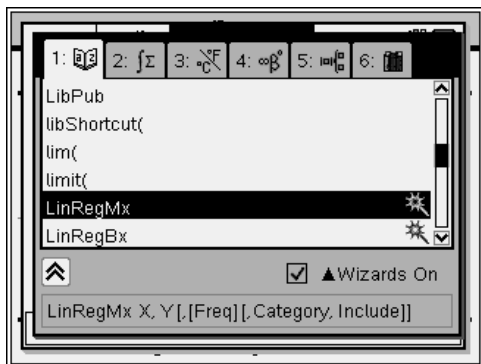

LinRegMx  
function in a  
CAS  
handheld

7. Press **(enter)**.

A wizard opens, giving you a labeled box to type each argument.

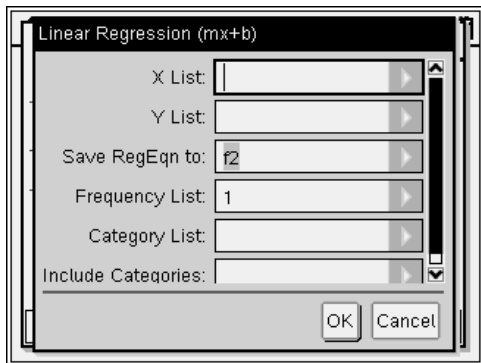

8. Type {1,2,3,4,5} as **X List**.
9. Press **(tab)** to move to the **Y List** field.
10. Type {5,8,11,14,17} as **Y List**.
11. If you want to store the regression equation in a specific variable, press **(tab)**, and then replace **Save RegEqn To** with the name of the function variable (f1 through f99).
12. Click **OK** to close the wizard and insert the expression into the entry line.

The expression is inserted along with statements to copy the regression equation and display the variable *stat.results*, which will contain the results.

LinRegMx {1,2,3,4,5},{5,8,11,14,17},1: CopyVar stat.RegEqn,f1:  
stat.results

The Scratchpad then displays the *stat.results* variables.

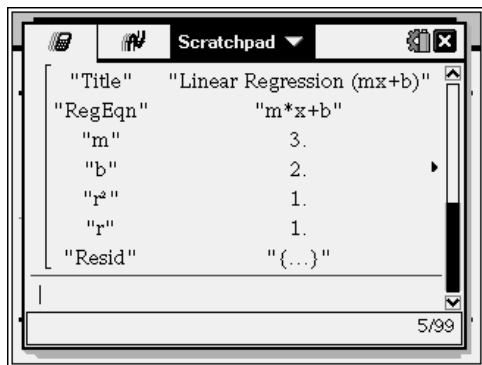

**Note:** You can copy values from the *stat.results* variables and paste them into the entry line.

## Viewing the History

Each evaluated expression and result becomes part of the Scratchpad history, displayed above the entry line.

- ▶ Press ▲ or ▼ to scroll through the history.

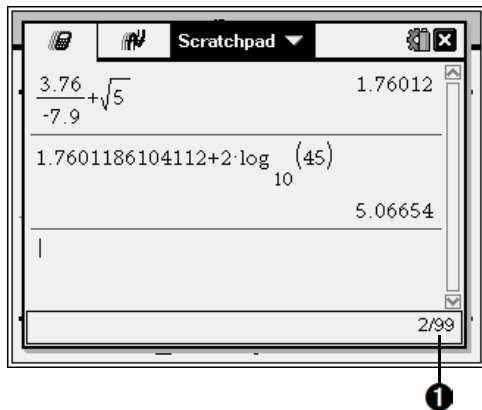

- 1 Current entry/total entries

## Copying a History Item to the Entry Line

You can quickly copy an expression, subexpression, or result from the history into the entry line.

1. Press  $\blacktriangle$  or  $\blacktriangledown$  to move through the history and select the item that you want to copy.
2. Optionally, select part of the expression or result by using  $\text{⇧shift}$  in combination with the arrow keys.



approx  $\frac{2^8 \cdot 12}{42}$  73.1428571429

3. Press  $\text{enter}$  to copy the selection and insert it into the entry line.



$\sqrt{\frac{2^8 \cdot 12}{42}}$   $\frac{16 \cdot \sqrt{14}}{7}$



$\sqrt{\frac{2^8 \cdot 12}{42}}$  8.55236

## Clearing the History

When you clear the history, all variables and functions defined in the history retain their current values. If you clear the history by mistake, use the undo feature.

- From the **Actions** menu, click **Clear History**.

—or—

Press  $\text{menu}$   $\text{1}$   $\text{5}$ .

All expressions and results are removed from the history.

## Editing Scratchpad Expressions

Although you cannot edit a Scratchpad Calculate expression in the history, you can copy all or part of an expression from the history and paste it to the entry line. You can then edit the entry line.

## Inserting Elements into the Entry Line

1. Press  $\text{tab}$ ,  $\blacktriangleleft$ ,  $\blacktriangleright$ ,  $\blacktriangle$ , or  $\blacktriangledown$  to position the cursor in the expression.



The cursor moves to the closest valid position in the direction that you press.

2. Type the elements.

—or—

Insert them from the Catalog.

## Selecting Part of an Expression

You can delete, cut, or copy a selected part of an expression.

1. Press  $\leftarrow$ ,  $\rightarrow$ ,  $\blacktriangle$ , or  $\blacktriangledown$  to move the cursor to a starting point in the expression.
2. Press and hold  $\text{⇧}$  and press  $\leftarrow$ ,  $\rightarrow$ ,  $\blacktriangle$ , or  $\blacktriangledown$  to select.
  - To delete the selection, press  $\text{⌫}$ .
  - To cut the selection to the Clipboard, press  $\text{⌘ X}$ .
  - To copy the selection to the Clipboard, press  $\text{⌘ C}$ .
  - To paste the selection to a new entry line in Scratchpad, press  $\text{⌘ V}$ .

## Graphing with the Scratchpad

1. Press  $\text{⌘ G}$  to open the Scratchpad Graph page if it's not already open.

By default, the entry line is displayed. The entry line displays the required format for typing a relation. The default graph type is Function, so the form  $f1(x)=$  is displayed.

If the entry line is not shown, press **Ctrl + G** or press  $\text{⌘ 2 3}$  to display the entry line and type an expression to graph.

2. Press  $\text{⌘ > Graph Entry/Edit}$  and select a graph type.

For example:

- To graph an equation for a circle, press  $\text{⌘ > Graph Entry/Edit > Equation > Circle > } (x-h)^2 + (y-k)^2 = r^2$  or press  $\text{⌘ 3 2 3 1}$ . Fill in the equation and press  $\text{⏏}$  to draw the circle.
- To graph a function, press  $\text{⌘ > Graph Entry/Edit > Function}$  or press  $\text{⌘ 3 1}$ .

The entry line changes to display the expression format for the specified graph type. You can specify multiple relations of each graph type.

- Type an expression and any other parameters required for the graph type.



- Press **(enter)** to graph the relation, or press **▼** to add another relation. If necessary, you can use press **(menu)** **(4)** to choose a tool on the **Window/Zoom** menu and adjust the viewing area.

When you graph the relation, the entry line disappears to show an uncluttered view of the graph. If you select or trace a plot, relation that defines the plot is displayed on the entry line. You can modify a plot by defining a relation or by selecting and changing the graph.

As you graph multiple plots, the defining relation is displayed for each. You can define and graph a maximum of 99 relations of each type.

- Use the **(menu)** key to explore and analyze the relation to:
  - Trace the relation.
  - Find points of interest.
  - Assign a variable in the expression to a slider.

## Viewing the Table

- To display a table of values corresponding to the current plots, press **(menu)** > **Table** > **Split-screen Table** **(menu)** **(7)** **(1)**.

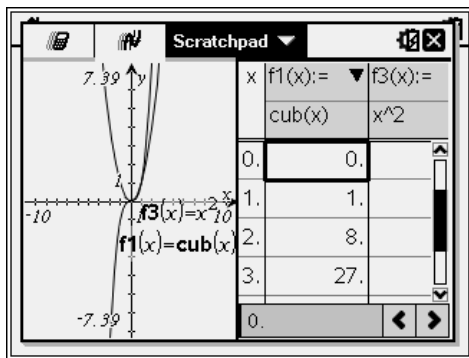

- ▶ To hide the table, click the graph side of the split screen, and then press (menu) > **Table** > **Remove Table** ((menu) (7) (2)).
- ▶ To resize columns, click the table and press (menu) > **Actions** > **Resize** ((menu) (1) (1)).
- ▶ To delete a column, edit an expression, or edit table settings, click the table and press (menu) > **Table** ((menu) (2)).

## Changing the Appearance of the Axes

As you work with graphs, the Cartesian axes are displayed by default. You can change the appearance of the axes in the following ways:

1. Press (menu) (4) and choose the Zoom tool.
2. Select the axes and press (ctrl) (menu) (2) to activate the **Attributes** tool.
  - a) Press ▲ or ▼ to move to the attribute to change. For example, choose the end style attribute.
  - b) Press ◀ or ▶ to choose the style to apply.
  - c) Change any other attributes of the axes as required for your work, and then press (enter) to exit the attributes tool.
3. Adjust the axes scale and tic mark spacing manually.
  - a) Click and hold one tick mark, and move it on the axis. The spacing and number of tic marks increases (or decreases) on both axes.
  - b) To adjust the scale and tic mark spacing on a single axis, press and hold (⇧shift), and then grab and drag a tic mark on that axis.
4. Change axis end values by double-clicking them and typing new values.
5. Adjust the location of the axes. To move the existing axes without resizing or rescaling them, click in and drag an empty region of the screen until the axes are in the desired location.
6. Change the axes' scales by pressing (menu) > **Window/Zoom** > **Window Settings** ((menu) (4) (1)).  
Type the values of your choice over the current values for x-min, x-max, y-min, and y-max, Xscale, and Yscale and click **OK**.
7. Press (menu) > **View** > **Hide Axes** ((menu) (2) (1)) to hide or show the axes.
  - If the axes are shown on the page, selecting this tool hides them.

- If the axes are hidden on the page, selecting this tool redisplay them.

## Tracing a Plot

Graph Trace moves through the points of a graphed function, parametric, polar, sequence, or scatter plot. To enable the trace tool:

1. Press **(menu) > Trace > Graph Trace (menu) (5) (1)** to move across the plot in Trace model.

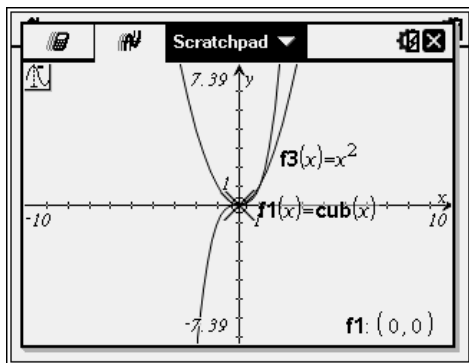

2. (Optional) To change the trace step increment for tracing, press **(menu) (5) (3)**.

After you type a different step increment, the Graph Trace tool moves across the graph in steps of that size.

3. Use Graph Trace to explore a plot in the following ways:
  - Move to a point and hover to move the trace cursor to that point.
  - Press **◀** or **▶** to move from point to point on the function's graph. The coordinates of each point traced are displayed.
  - Press **▲** or **▼** to move from one plot to another. The point's coordinates update to reflect the new location of the trace. The trace cursor is positioned on the point of the new graph or plot with the closest x value to the last point identified on the previously traced function or graph.
  - Type a number and press **(enter)** to move the trace cursor to the point on the plot with independent coordinates nearest the typed value.

- Create a persistent point that remains on the graph by pressing **(enter)** when the trace point reaches the point you want to label. The point remains after you exit Graph Trace mode.

**Notes:**

- The string *undef* is displayed instead of a value when you move over a point that is not defined for the function (a discontinuity).
- When you trace beyond the initially visible graph, the screen pans to show the area being traced.

4. Press **(esc)** or choose another tool to exit Graph Trace.

**Finding Points of Interest**

You can use the tools on the **Analyze Graph** menu to find a point of interest in a specified range of any graphed function. Choose a tool to find zero, the minimum or maximum, the point of intersection or inflection, or the numeric derivative (dy/dx) or Integral on the graph.

1. Select the point of interest that you want to find on the **Analyze Graph** menu. For example, to find a zero, press **(menu) (6) (1) ..**

	<b>non-CAS</b>	<b>CAS</b>
Zero	<b>(menu) (6) (1)</b>	<b>(menu) (6) (1)</b>
Minimum	<b>(menu) (6) (2)</b>	<b>(menu) (6) (2)</b>
Maximum	<b>(menu) (6) (3)</b>	<b>(menu) (6) (3)</b>
Intersection	<b>(menu) (6) (4)</b>	<b>(menu) (6) (4)</b>
Inflection	Not applicable	<b>(menu) (6) (5)</b>
dy/dx	<b>(menu) (6) (5)</b>	<b>(menu) (6) (6)</b>
Integral	<b>(menu) (6) (6)</b>	<b>(menu) (6) (7)</b>
Analyze Conics	<b>(menu) (6) (7)</b>	<b>(menu) (6) (8)</b>

The icon for the selected tool displays at the top left on the work area. Point to the icon to view a tooltip about how to use the selected tool.

2. Click the graph you want to search for the point of interest, and then click a second time to indicate where to start the search for the point.

The second click marks the lower bound of the search region and a dotted line displays.

**Note:** If you are finding the derivative ( $dy/dx$ ), click the graph at the point (numeric value) to use for finding the derivative.

- Press  $\leftarrow$  or  $\rightarrow$  to move the dotted line that marks the search region, and then click the point at which you want to stop the search (upper bound of the search region).

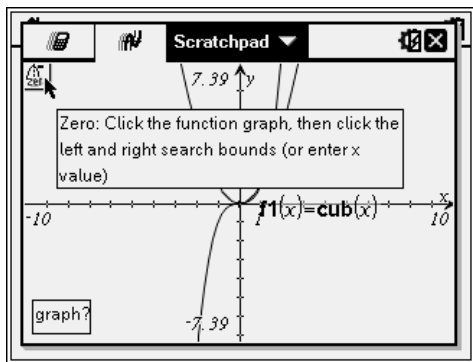

- Press  $\text{(enter)}$  at the point to start the search. The tool shades the range.

If the search region you specified includes the point of interest, a label for the point displays. If you change a graph that has points of interest identified, be sure to check for changes in points of interest. For example, if you edit the function on the entry line or manipulate a plot, the point where the graph intersects zero can change.

The labeled points of interest remain visible on the graph. You can exit the tool by pressing  $\text{(esc)}$  or choosing another tool.

## ***Working with Variables in the Scratchpad***

Scratchpad variables are shared between Scratchpad Calculate and Scratchpad Graph, but not with any TI-Nspire™ documents. If you use the same name for a Scratchpad variable and a variable in a document, no conflict occurs unless you attempt to copy expressions between documents and the Scratchpad.

## ***Saving the Scratchpad Contents***

You can save the Scratchpad Calculate page, the Scratchpad Graph page, or both as a TI-Nspire™ document.

- Press  $\text{(doc)}$ , and then select **Save to Document** ( $\text{(doc)}$   $\text{[A]}$ ).

2. Press **enter**.

The Save to Document dialog box opens.

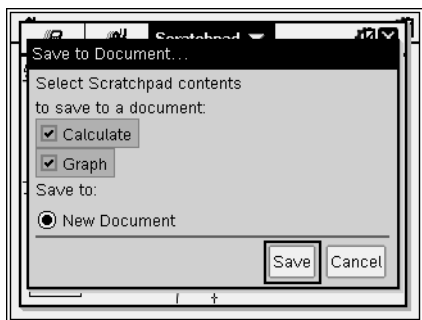

3. Select the page or pages to save.
4. If a document is open, select either New or Current document.
5. Click **Save**.
  - If you selected to save to a current (open) document, the Scratchpad pages are added to the document.
  - If you selected to save the Scratchpad pages to a new document, the pages are converted to an unsaved document. To save the document:
    - Press **doc** > **Save**. The Save As dialog box opens.
    - Type a name for the document.
    - Select **Save** to save the new document.

## ***Clearing Scratchpad Contents***

Complete the following steps to delete the calculations and graphing work from the Scratchpad application.

1. Press **doc** > **Clear Scratchpad** (**doc** **B**).
2. Press **enter** to delete the Scratchpad contents.





# Working with Documents on TI-Nspire™ Handhelds

All of the work you do with a TI-Nspire™ handheld is contained in one or more TI-Nspire™ documents, which you can share with other handheld users and with those using the computer software.

- Each document is divided into at least one, and up to 30, problems.
- Each problem contains at least one, and up to 50, pages.
- Each page can be divided into as many as four work areas.
- Each work area can contain any of the TI-Nspire™ applications (Calculator, Graph, Geometry, Lists & Spreadsheet, Data & Statistics, Notes, and Vernier DataQuest™).

## Opening a Document

1. From the Home screen, select My Documents.

—or—

Press **(2)**.

The file manager opens.

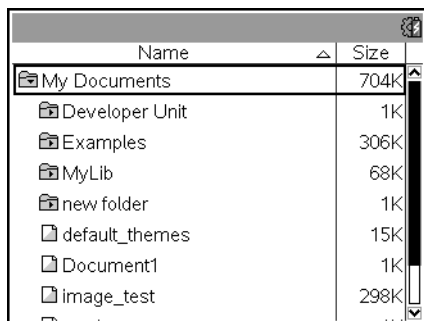

2. Navigate to the file you want to open.
  - Press **▼** to highlight the document name, and then press **(doc)** or **(enter)** to open the document.
  - If the file is in a folder, press **▼** to highlight the folder, and then press **(doc)** or **(enter)** to open the folder.
3. Press **(doc)** to open the Documents menu to access options for working with the open document.

## Creating a New Document

1. From the Home screen, select New Document.

—or—

Press **1**.

You can also press **ctrl** **N**.

A new document opens with a list of applications.

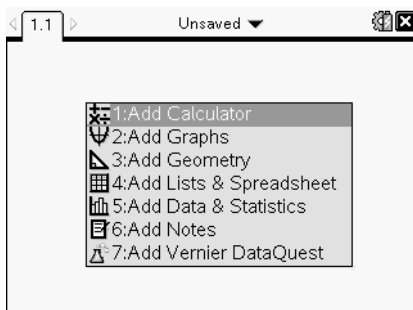

**Note:** The tab at the top left of the screen indicates that this is the first page of the first problem.

2. Use **▼** and **▲** to highlight the application you want to add to the page, and then press **enter** to open the page.

## Saving Documents

To save the document in the My Documents folder:

1. Press **(doc)** to open the Documents menu, and then select **File > Save**.

**Note:** You can also press **(doc)** **(1)** **(4)** or **(ctrl)** **(S)** to save a document.

The Save As dialog box opens.

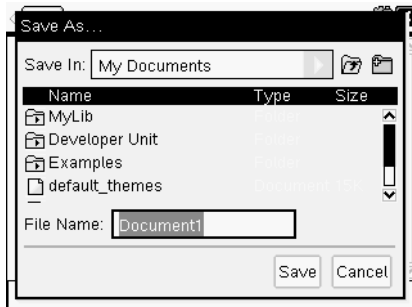

If you are saving the document for the first time, you will be asked which folder to save it to, and what to name the document. The default folder is My Documents.

2. Type a name for the document.
3. Click **Save** to save the document in the My Documents folder.

### Saving a Document in a Different Folder

To save the document in a different folder:

1. From an open document, press **(doc)** **(1)** **(5)**.

The Save As dialog box opens.

2. Press **(shift)** **(tab)** to navigate to the list of existing folders. The first folder in the list is selected.
3. Use the **▼** and **▲** to scroll through the list of folders.
4. To select and open a folder, press **(enter)**.
5. Type a name for the document.
6. Click **Save** to save the document in the selected folder.

### Saving a Document in a New Folder

To save the document in a new folder:

1. From an open document, press **(doc)** **(1)** **(5)**.

The Save As dialog box opens.

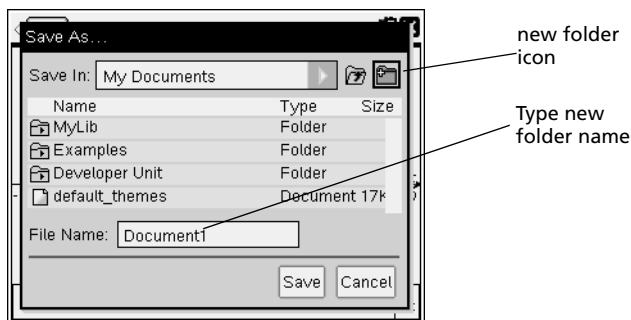

2. Press **(tab)** until the New Folder icon is highlighted, and then press **(enter)** to create a new folder.

The new folder is added to the bottom of the list of existing folders. By default, the folder name is "Folder1."

3. Type a name for the new folder, and then press **(enter)** to save.
4. Press **(enter)** again to open the folder.

The File Name field becomes active.

5. Type a name for the document.
6. Click **Save** to save the document in the new folder.

## ***Working with Applications***

Options for working with applications include:

- Creating a new document and selecting an application
- Adding a new page and application to an open document
- Adding multiple applications to a page in a document

### **Adding an Application**





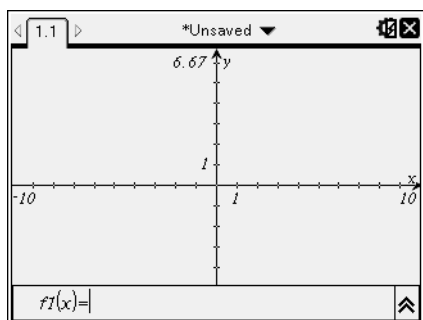

There are multiple ways to add an application to a page:

- When creating a new document, use the Touchpad or corresponding numbers to select an application from the list of applications.
- To add a new page and application to an open document, press **(ctrl)** **(doc)**, and then select an application from the list.

For example, press **(2)** to add the Graph application to the page. The application opens in the work area.



You can also press **( on)**, and then select an application from the Home screen by clicking one of the following application icons:

	Calculator
	Graphs
	Geometry
	Lists & Spreadsheet
	Data & Statistics
	Notes
	Vernier DataQuest™

## Using Multiple Applications on a Page

You can add up to four applications to each page.

When you create a new document, it contains space to add one application. If you need to add more than one application to a page, you can change the layout to accommodate as many as four applications.

You can choose a standard layout, provided as a menu item, or you can customize a layout to suit your needs.

## Choosing a Standard Page Layout

1. Press **(doc)** **(5)** **(2)** to display layout options.

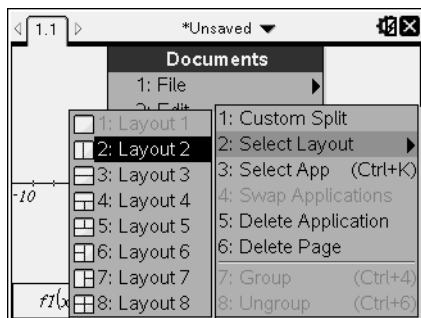

2. Press the number that corresponds to the layout you want.

For example, press **(2)** to create a two-pane layout, divided vertically on the page.

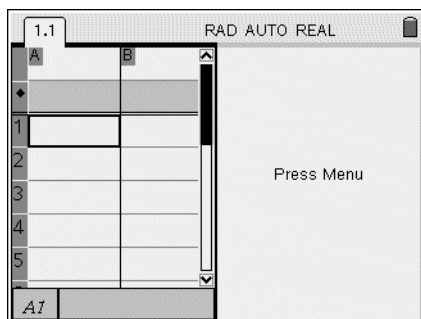

3. Press **(ctrl)** **(tab)** to move between panes. Bold lines around the pane indicate that the pane is active.
4. Press **(menu)**, and then press the number of the application you want to add the new pane. For example, press **(4)** to add the Lists & Spreadsheet application.

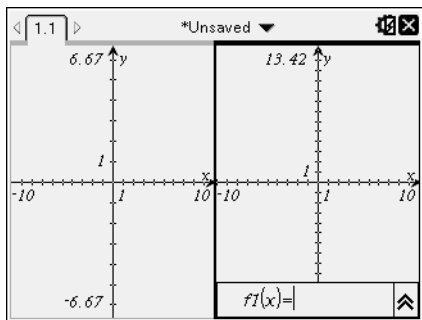

**Note:** If you need to change the layout of the page to add or delete applications, you can do so at any time. When deleting an application, select the application to be deleted first.

### Creating a Custom Page Layout

If the standard layouts do not meet your needs, you can customize the space allotted to applications on a page.

1. Press **(doc)** **(5)** to display layout options.

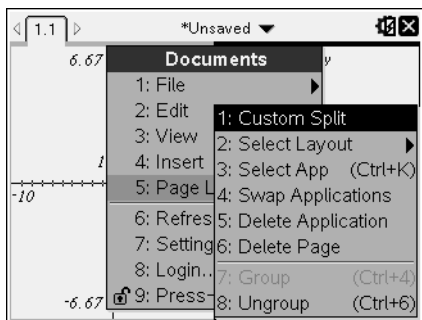

2. Press **(1)** to select the custom split option.

The standard layout is displayed with a divider between the application panes. Use the arrows () in the middle of the divider to adjust the size of the panes.

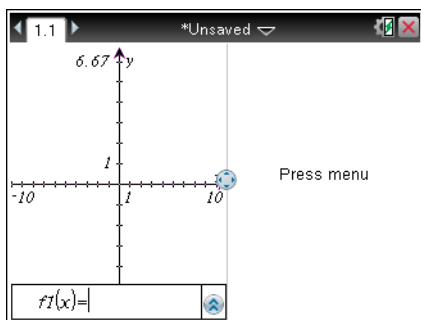

3. Press  $\blacktriangle$ ,  $\blacktriangledown$ ,  $\blacktriangleleft$ , or  $\blacktriangleright$  to move the divider to adjust the height or width of the panes in the layout.
4. Press  $\oplus$  or  $\ominus$  to select a defined layout:
  - Pressing  $\ominus$  returns to a full page layout.
  - Pressing  $\oplus$  once switches layout from a vertical layout to a horizontal layout. Press  $\ominus$  to go back to a vertical layout.
  - Pressing  $\oplus$  twice adds a third pane to the page. Pressing  $\oplus$  multiple times enables you to choose between a vertical and horizontal page layout with three panes.
  - Pressing  $\oplus$  five times adds a fourth pane to the page. Press  $\ominus$  to cycle through the previous layout options.
5. Press  $\left[ \text{Layout} \right]$  or  $\left[ \text{enter} \right]$  to accept the layout dimensions.
6. Press  $\left[ \text{ctrl} \right] \left[ \text{tab} \right]$  to move between panes. Bold lines around the pane indicate that the pane is active.

### **Swapping Applications on a Page**

If you want to change the position of applications on a page with multiple applications, you can do so by “swapping” the positions of two applications.

1. Press  $\left[ \text{doc} \right]$   $\left( 5 \right)$  Page Layout  $\left( 4 \right)$  Swap Application.

The selected application is surrounded by a heavy, flashing black border, and the Swap App cursor  $\curvearrowright$  is displayed on the screen.

**Note:** On a two-pane page layout, the selected application automatically swaps position with the opposite pane. Press  $\left[ \text{Layout} \right]$  or  $\left[ \text{enter} \right]$  to complete the swap.



2. Press **▲**, **▼**, **◀**, or **▶** to position the cursor over the application you are targeting to swap.
3. Press  or **enter** to complete the swap.

**Note:** Press **esc** to cancel the swap.

## Grouping Applications

To group up to four application pages into a single page:

1. Select the first page in the series.
2. From the **Document** menu, select **Page Layout > Group**.

Press **doc▼** **5** **7**.

The next page is grouped with the first page. The page layout automatically adjusts to display all the pages in the group.

## Ungrouping Pages

To ungroup the pages:

1. Select the grouped page.
2. From the **Document** menu, select **Page Layout > Ungroup**.

—or—

Press **doc▼** **5** **8**.

The material becomes individual pages for each application.

## Deleting an Application from a Page

1. Click the application you want to delete.
2. From the **Document** menu, select **Page Layout > Delete Application**.

—or—

Press **doc▼** **5** **5**.

The selected application is deleted.

If you want to undo the delete, press **Ctrl-Z**.

## Using the Application Menu

The Application menu enables you to select tools for working with a specific application. Each application has a unique menu.

### Using the Application Menu

1. From a blank page, press **menu** to display the Application menu.

The menu displays applications that you can add to the page.

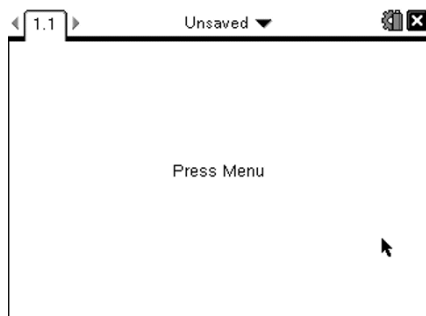

2. Press the number of the application you want to add to the page. For example, press **4** to add the Lists & Spreadsheet application.

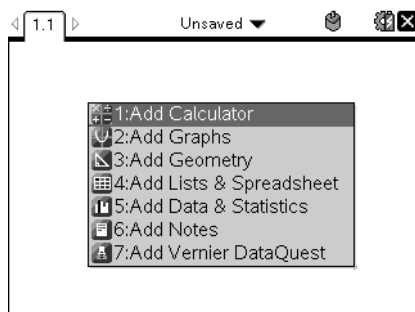

3. Press **menu** to display the Application menu, which lists the options for working with the current application.

The example below displays the Application menu for the Lists & Spreadsheet application.

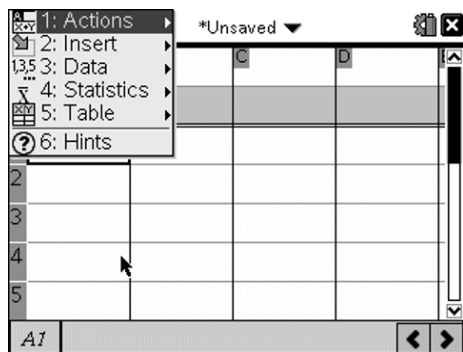

## Context Menus

Context menus display options that are specific to the selected object or the current cursor location.

### Using the Context Menu

- ▶ To access a context-sensitive menu from an application, press **ctrl** **menu**.

In the example below, the context menu displays options available for the selected cell in Lists & Spreadsheet.

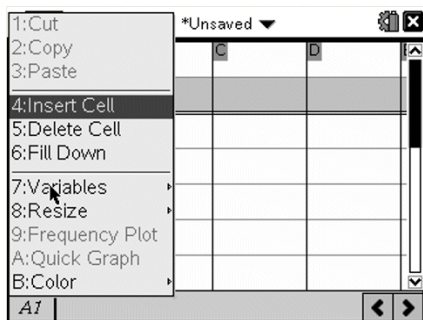

## Working with Problems and Pages

The options on the **Documents** menu let you:

- Save a document
- Access edit functions such as undo, redo, cut, copy, paste, and delete
- Move between pages and open the page sorter view for documents with multiple pages
- Modify page layout, insert pages or problems, delete pages, and change settings
- Add problems, pages, and applications to open documents
- Access page layout options

### Adding a Problem to a Document

Adding problems to a document enables you to reuse variable names. A document can contain as many as 30 problems. To add a new problem:

1. Press **doc** **4** **1** to open the Insert options.

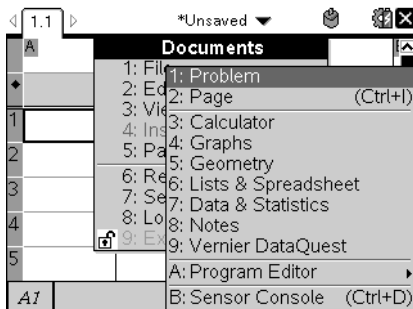

A new problem with one page is added to the document. The tab at the top left of the screen indicates that this is the first page of the second problem.

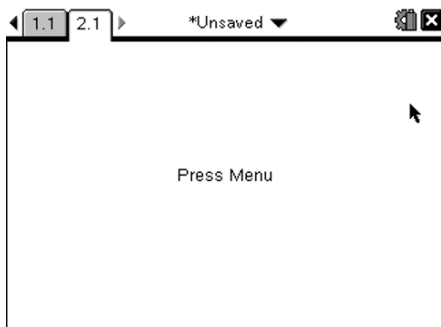

2. Press **(menu)** to open the Application menu, and then press the number corresponding to the application you want to add to the new page.

## ***Viewing and Reordering Pages in a Document***

The Page Sorter displays all of the problems in your document and all pages within each problem in thumbnail format. You can use the Page Sorter to rearrange and delete pages, copy a page from one problem and paste it into another, and apply templates to pages.

### **Viewing Multiple Pages with the Page Sorter**

Although the handheld typically displays the pages in your document one at a time, the Page Sorter lets you see all of the problems in your document and all pages within each problem in thumbnail format. You can use the Page Sorter to rearrange and delete pages, and copy a page from one problem and paste it into another.

## Opening the Page Sorter from a Document

- ▶ Press **(ctrl) ▲**.

The Page Sorter screen displays all of the problems and pages in the current document.

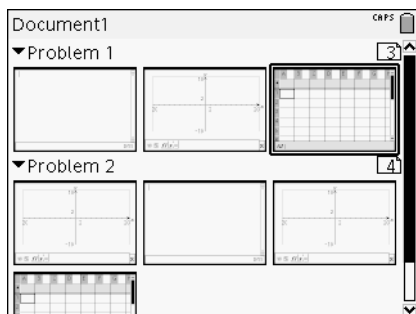

## Reordering Pages in a Problem

Use the Page Sorter (press **(ctrl) ▲**) to move a page within a problem with multiple pages:

1. Press the **◀** or **▶** key to select the page you want to move.

A heavy border around the page indicates that it is selected.

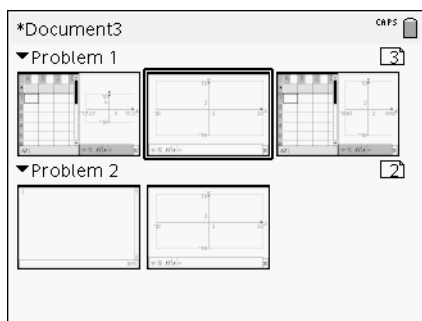

2. Either press and hold **(left arrow)** or press **(ctrl) (left arrow)** until the grab cursor **(hand icon)** is displayed.
3. Press **◀**, **▶**, **▲** or **▼** to move the page to the desired position.
4. Press **(hand icon)** or **(enter)** to finish the move.

**Note:** You can press **(esc)** to cancel.

The page moves to the new location within the problem, and the counter adjusts accordingly.

## Copying a Page to Another Problem

To copy a page from one problem to another in the same document:

1. Press **(ctrl)** **(▲)** to open Page Sorter.
2. Press **(◀)**, **(▶)**, **(▲)**, or **(▼)** to select the page you want to copy.

A heavy border around the page indicates that it is selected.

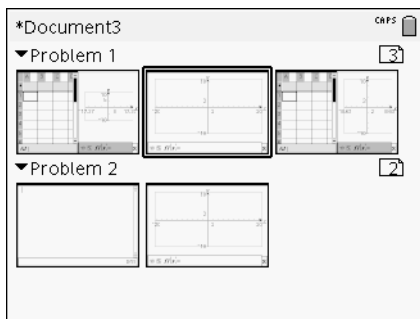

3. Press **(ctrl)** **(C)** to copy the page.
4. Press **(▶)**, **(▶)**, **(▲)**, or **(▼)** to select the desired position in the problem where you will paste the page. The copied page will be placed after the page you select.
5. Press **(ctrl)** **(V)** to paste the page in the new location.

The page is copied to the new location within the problem, and the counter adjusts accordingly.

**Note:** If the page contains variables with the same names as the new problem, a conflict may occur. Rename the variables if necessary.

## Copying a Page to Another Document

To copy a page from one document to another document:

1. Press **(ctrl)** **(▲)** to open the Page Sorter.
2. Press **(▶)**, **(▶)**, **(▲)**, or **(▼)** to select the page you want to copy.  
A heavy border around the page indicates that it is selected.
3. Press **(ctrl)** **(C)** to copy the page.
4. Press **(on)** **(2)** to open My Documents.
5. Press **(▲)** and **(▼)** to highlight the folder containing the document you want to copy the page to.
6. Press **(▶)** to open the folder.

—or—

Press **menu** **3**.

- Press the ▲ and ▼ keys to highlight the document.
- Press **enter** or **enter** to open the document.
- Press **ctrl** ▲ to display the Page Sorter.
- Press ◀, ▶, ▲, or ▼ to move the page to the desired position in the document.
- Press **ctrl** **V** to paste the page in the new location.

The page moves to the new location within the problem, and the counter adjusts accordingly.

## ***Copying, Pasting, and Deleting Problems***

You can copy and paste a single problem from one location to another within the same document or a different document. You can also delete a problem from the document.

### **Copying and Pasting a Problem**

To copy and paste a problem:

- Open the Page Sorter.

Press **ctrl** ▲.

—or—

Press **doc** **3** **3**.

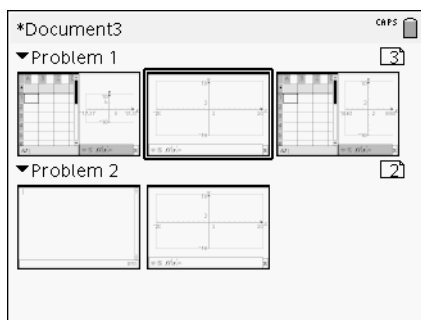

- Select the problem. If there are multiple problems, you can press **menu** **2** to collapse the Page Sorter to list the problems by number and title only.

3. Press **(ctrl) [C]**.
4. Go to the location where you want the problem to appear.
5. Press **(ctrl) [V]**.

A duplicate problem is placed in the new location.

## **Deleting a Problem**

To delete a problem from the document:

1. Select the problem from the Page Sorter.
2. Press **(ctrl) [X]**.

The problem is deleted from the document.

## **Renaming a Problem**

To rename a problem:

1. With the document active, open the Page Sorter.  
Press **(ctrl) ▲**.
2. Select the problem name.
3. Press **(ctrl) (menu)**.
4. Select **(7) Rename** and type the name.
5. Press **(ctrl) [S]** to save the change.

## **Adding a Page to a Problem**

Each problem can contain up to 50 pages. To add a new page to a problem:

- ▶ Press **(ctrl) (doc ▾)** or **(ctrl) [I]** to add a blank page and select an application.

—or—

- ▶ Press **(ctrl) (on)** to display the **Home** screen, and then point to the application you would like to add to the new page and click or tap.

A new page is added to the current problem.



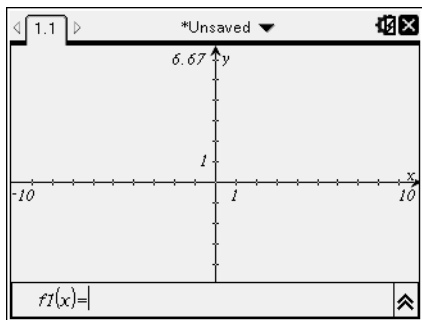

**Note:** The tab at the top left of the screen indicates that this is the second page of the second problem.

## ***Moving Through Pages in a Document***

Tabs display up to three multiple pages. When a document contains more than three pages, arrows appear on the left and right of the tabs.

Use the following keys to navigate through your documents.

- $\textcircled{\text{ctrl}}$  ◀ displays the previous page.
- $\textcircled{\text{ctrl}}$  ▶ displays the next page.
- $\textcircled{\text{ctrl}}$  ▲ displays the Page Sorter.
- $\textcircled{\text{ctrl}}$  ▼ displays the previous view.
- Use the Touchpad to click on the arrows that appear on either side of the tabs to show additional pages in a document containing more than three pages.

## ***Managing Documents***

My Documents is a file manager in which you store and organize your documents. The example below illustrates the My Documents screen with its main parts labeled. Following the screen, you can find descriptions of each labeled part.

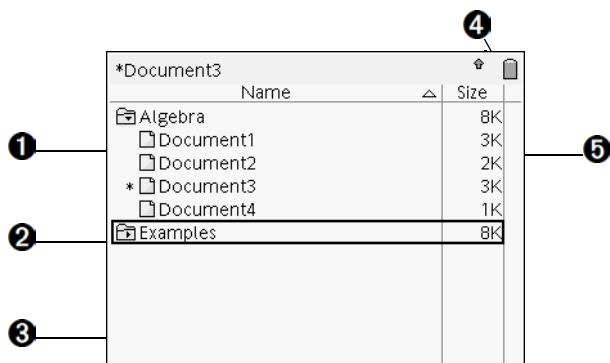

- ❶ Expanded folder
- ❷ Current, unsaved document
- ❸ Collapsed folder
- ❹ System status indicators
- ❺ File size

## Browsing Files in My Documents

To open **My Documents**:

- ▶ Press **(on)** **(2)**.

**Note:** If you are working in a page, press **(ctrl)** **(ctrl)** **(ctrl)**.

The **My Documents** screen opens, displaying all folders and files on the handheld.

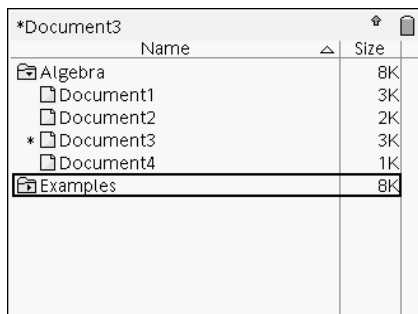

- To sort columns by name or size, click that column head. Click again to change the sort from ascending to descending.
- To scroll through My Documents, click or grab the scroll bar.
- To expand a single folder, point to the folder and click on the folder icon or press **(ctrl) ▶**. To collapse, click again or press **(ctrl) ◀**.
- To expand all folders, press **(menu) (7)**. To collapse, press **(menu) (8)**.

## Renaming Folders or Documents

To rename a folder or document:

1. Press the **▲** and **▼** keys to highlight the document or folder you want to rename.
2. Press **(menu) (2)**.

Document3		CRFS
Name	Size	
Algebra	8K	
<b>Document1</b>	3K	
Document2	2K	
Document3	3K	
Document4	1K	
Examples	8K	

The document or folder name is highlighted.

3. Type a new name and press **(enter)** to complete the change.

**Note:** Press **(esc)** to cancel.

## Creating Folders

You can create folders two different ways:

- You can create a folder when you save a new document: The **Save** and **Save As** menu commands allow you to enter a new folder name for the document.
- You can create a folder directly from the My Documents screen. Press **(menu) (1)**. Type a name for new folder, and press **(enter)** or **(add)** to add it.

## File and Folder Naming Conventions

Folder names must be unique. File and folder names can be very long, and can include almost all characters, including spaces and punctuation.

**Note:** If you are planning to transfer these documents to your computer for use in the TI-Nspire™ software, it is best to use names that are accepted on your computer. Avoid punctuation, \, /, or symbols.

## Deleting Documents and Folders

1. Press  $\blacktriangle$  and  $\blacktriangledown$  to highlight the document or folder you want to delete.
2. Press  $\text{ctrl}$   $\text{menu}$   $\text{6}$ .

—or—

Press  $\text{del}$ .

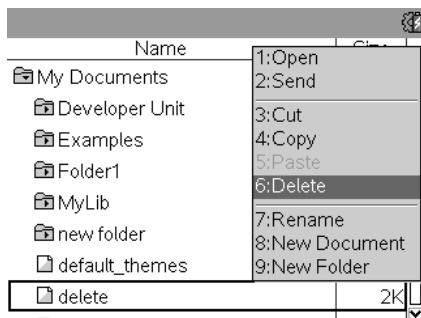

A dialog box opens, confirming that you want to delete the file or folder.

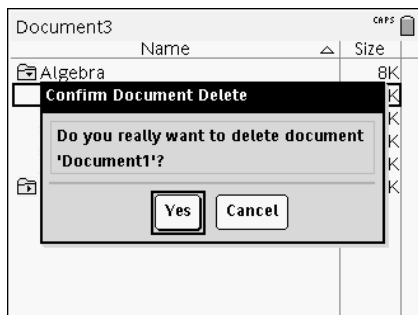

3. Press  $\text{enter}$  or  $\text{del}$  to select **Yes**.

The document is deleted.

## Duplicating Documents and Folders

Use Copy (ctrl) **C** and Paste (ctrl) **V** to duplicate documents and folders.

To copy a document to another folder, select the desired folder, and then paste.

## Recovering Deleted Documents

Most operations performed in My Documents can be undone. Press (ctrl) **Z** (Undo) to cancel the last operation until the deleted document is restored.

## Closing a Document

1. To close a document, press (doc) **1** **3**.

—or—

Press (ctrl) **W**.

If you have changed the document, you will be asked whether you want to save those changes.

2. Click **Yes** to save the document or click **No** to abandon the changes.

## Understanding the TI-Nspire™ Tools

This section provides an overview of the tools used when working with TI-Nspire™ documents on a handheld, including variables, catalog, symbols, and math templates.

### Creating TI-Nspire™ Variables

Variables can be any portion or attribute of an object or function created within an application. Examples of attributes that can become variables are the area of a rectangle, the radius of a circle, the value contained in a spreadsheet cell or the contents of a column, or a function expression. When you create a variable, it is stored in memory within the problem. You will find more information about variables in the chapter titled *Using Variables*.

### Using the Catalog

Use the catalog to access a list of TI-Nspire™ commands and functions, units, symbols and expression templates. Commands and functions are listed alphabetically. Commands or functions not beginning with a letter are found at the end of the list (&, /, +, -, and so on). To open the catalog:

1. From an open document, press (cat) to open the catalog.

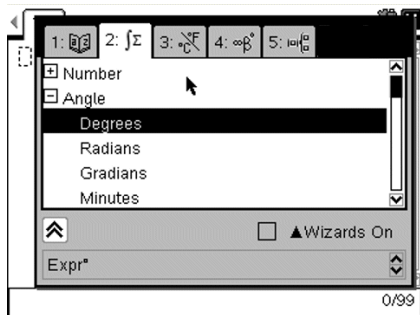

2. Press the number key corresponding to the appropriate tab.

For example, press **(2)** to show a list of math functions.

3. Press **▼** until the item you want to insert is highlighted.

A syntax example for the selected item is displayed at the bottom of the screen.

**Note:** To see additional syntax examples of the selected item, press **(tab)**, and then press **(enter)** to maximize or minimize the Help. To move back to the selected item, press **(shift) (tab)**.







4. Press **(enter)** to insert the item.

### **About the Catalog Window**

The catalog window uses these tabs to categorize commands, special characters, and templates in documents:

1: [book icon]	Contains all commands and functions, in alphabetical order
2: [math symbol]	Contains all math functions
3: [infinity symbol]	Provides a symbol palette for adding special characters
4: [math symbol]	Contains math templates for creating two dimensional objects, including product, sum, square root, and integral
5: [book icon]	Shows public library (LibPub) objects

## CAS:

1: 	Contains all commands and functions, in alphabetical order
2: 	Contains all math functions
3: 	Provides the values for standard measurement units
4: 	Provides a symbol palette for adding special characters
5: 	Contains math templates for creating two dimensional objects, including product, sum, square root, and integral
6: 	Shows public library (LibPub) objects

## Using Wizards

Some catalog functions have a wizard to help you enter function arguments. To use a wizard, press **(tab)** until the **Wizards On** box is highlighted. Press  or **(enter)** to select the check box.

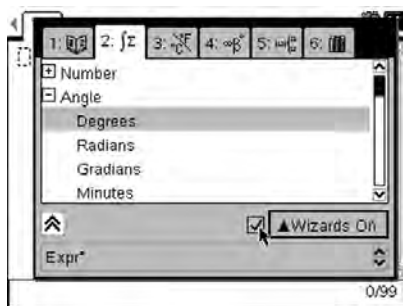

## Entering Special Characters

The symbol palette contains a subset of the objects found in the catalog. To open the symbol palette:

1. In an open document, press **(ctrl)** .

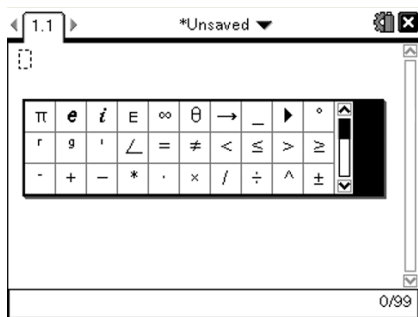

2. Press  $\leftarrow$ ,  $\rightarrow$ ,  $\uparrow$ , or  $\downarrow$  to select a symbol.
3. Press  $\text{enter}$  to insert the symbol.

## Entering Math Expressions

Use math expression templates to create two-dimensional objects such as summation, integral, derivative, and square root. To open the math expressions palette:

1. In an open document, press  $\text{math}$ .

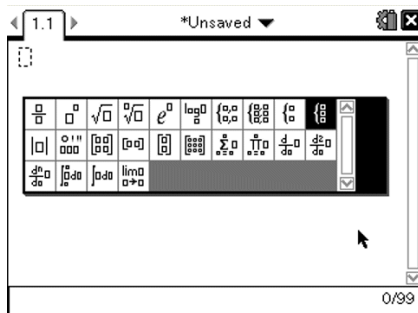



2. Press  $\leftarrow$ ,  $\rightarrow$ ,  $\uparrow$ , or  $\downarrow$  to select an expression.
3. Press  $\text{math}$  or  $\text{enter}$  to insert the expression.

## Entering International Language Characters

Use the  $\text{P}$  key to enter specially accented or punctuated characters in applications such as Notes that allow text input.

1. Open an application such as Notes that allows text input.
2. Type the desired text.



3. Position the cursor after the letter that you want to accent. For example, "e" while in the French locale.
4. Press  on the keypad. Notice that the "e" changes to "é." Keep pressing  until you find the accented version of e that you want. Press  or the next letter of your text to accept the character and continue typing.



# Working with Images

Images can be used in TI-Nspire™ applications for reference, assessment, and instructional purposes. You can add images to the following TI-Nspire™ applications:

- Graphs & Geometry
- Data & Statistics
- Notes
- Question, including Quick Poll

In the Graphs & Geometry and Data & Statistics applications, images are set in the background behind the axis and other objects. In the Notes and Question applications, the image is set at the cursor location inline with the text (in the foreground).

You can insert the following image file types: .jpg, .png, or .bmp.

**Note:** The transparency feature of a .png file type is not supported. Transparent backgrounds are displayed as white.

## *Working with Images on a Handheld*





On a handheld, images can be copied from one document to another or resized or repositioned within a document. You can also delete images from a document.

You cannot add or insert images into a document when working on a handheld. However, you can transfer a document containing an image from your computer to a handheld. If using a TI-Nspire™ CX handheld, colors are retained. If transferred to a TI-Nspire™ handheld, the colors in the image are converted to gray scale.

**Note:** If there is not enough memory on the handheld to accommodate a document containing an image, an error message is displayed.





### **Copying an Image**

Complete the following steps to copy an image from one document to another or from one page to another within the same document.



1. Open the document that contains the image you want to copy.
2. Select the image.
  - In the Question or Notes applications, move the cursor over the image and press .
  - In the Graphs & Geometry application, press    .



- In the Data & Statistics application, press   .

A border appears around the image.

3. Press  , and then click **Copy**. You can also press  .
4. Open the document where you want to paste the image or select a page in the current document.

**Note:** If you open a new document, you will be prompted to save and close the current document.









5. Press  .





**Note:** If pasting an image into the Graphs & Geometry application, press , and then press  .

The image is copied to the page in the document.

## Repositioning an Image









Complete the following steps to reposition an image on a page.

1. Open the document and navigate to the page that contains the image.
2. Select the image.
  - In the Question or Notes applications, move the cursor over the image, and then press, hold, and release . The image appears shaded.
  - In the Graphs & Geometry application, press    .
  - In the Data & Statistics application, press   .

A border appears around the image.
3. Move the image.
  - In the Question or Notes applications, move the cursor to the new location and press .
  - In the Graphs & Geometry or Data & Statistics applications:
    - Press and hold  until the cursor changes to a four-sided arrow (  ). The image floats in the background and the border changes to a dashed line.
    - Move your finger over the Touchpad to move the image to the new location, and then press  or  to place the image.

## Resizing an Image

Complete the following steps to resize an image on a page.

1. Open the document that contains the image.
2. Select the image.
  - In the Question or Notes applications, or in Quick Poll, move the cursor over the image and press, hold, and then release . The image appears shaded.
  - In the Graphs & Geometry application, press    .
  - In the Data & Statistics application, press   .

A border appears around the image.

3. Move the cursor to one of the corners.

The cursor changes to a four-sided directional arrow ().



**Note:** If you move the cursor to the edge of an image, the cursor changes to a two-sided directional arrow. You can drag the image left or right to resize it, but the image will become distorted.

4. Press .

The  tool is enabled.









5. Move your finger over the Touchpad in any direction to resize the image.

A dashed line appears to indicate the new size.



6. To accept the new size, press  or .

## Deleting an Image

Complete the following steps to remove an image from a page.

1. Open the document that contains the image.
2. Select the image.
  - In the Question or Notes applications, move the cursor over the image, and then press, hold, and release . The image appears shaded.
  - In the Graphs & Geometry application, press    .
  - In the Data & Statistics application, press   .

A border appears around the image.

3. Press  , and then select **Delete**.

The image is removed.

**Note:** In the Question and Notes applications, you can also press  to remove a selected image.

# Working in a TI-Nspire™ Navigator™ Teacher Software Classroom

If you are in a classroom where TI-Nspire™ Navigator™ Teacher Software is used, you will need to log in to class to communicate with the teacher's computer. The teacher can communicate with your handheld in the following ways:

- Send files
- Collect files
- Delete files
- Send Quick Polls

The teacher can also pause and restart your handheld. When class is paused, you will receive a message on your handheld. You cannot use your handheld until the teacher releases the handheld from pause mode.

## Logging In

Complete the following steps to connect to a classroom session.

1. From the Home screen, press (5) (5). From an open document, press (doc) (8).

The **Login to Class** dialog box opens.







2. Type your user name and password.
3. Click **Login**.

The Login Successful screen opens.

4. Click **OK**.

## TI-Nspire™ Handheld Login Status Icons

The icons on the TI-Nspire™ CX, TI-Nspire™ CX CAS, TI-Nspire™, and TI-Nspire™ CAS handheld screens indicate the communication status between the handheld and the access point, wireless adapter, wireless cradle, or TI-Navigator™ network. The icons indicate status as follows.

Icon	Status	Meaning
	Blinking	The handheld is searching for an access point.
	Solid	The handheld has found an access point.
	Solid	The handheld is not communicating with the adapter or cradle. Unattach the handheld from the adapter or cradle, wait for the icon to disappear, and then reattach the handheld to the adapter or cradle.
	Blinking	The handheld is connected to the network and is ready to login.
	Solid	The handheld is logged in to the network and is fully charged.

## Pausing a Class Session

There are times when a teacher may want to pause a class. Pausing a class suspends all activity on your handheld. When the teacher resumes class, the message clears and you are able to use the handheld.

## Understanding File Transfers

During a class session, the teacher may send, collect, or delete files. If she sends files, you see a dialog box with the options to Open, Go To, or Cancel. If she collects or deletes files, you see a dialog box that tells you a file transfer has been made, and your only option is to choose Cancel to close the box.

**Note:** If the teacher sets up actions to send or collect files before the class session starts, those actions take place when you log in. If she sets up multiple actions, such as both sending and collecting files, the only dialog box you will see is the one for the last action to take place.

See the section below for more information on each option.



## Opening Files

When the teacher sends a file to your handheld, the Transfers Complete dialog box opens.

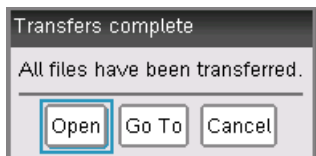

- ▶ Click **Open** to open the file. If the teacher sent multiple files, this opens the last file in the list.  
**Note:** The files are sent alphabetically by name, no matter which order the teacher sent them in. The last file in the list is the last alphabetical file.
- ▶ Click **Go To** to go to the location on the handheld where the file was sent. The file name is highlighted. You can open that file, or navigate to another file. If the teacher sent multiple files, the last alphabetical file in the list is highlighted.
- ▶ Click **Cancel** to dismiss the dialog box without opening the file. Your handheld returns to the state it was in when the message was sent.

## Collecting or Deleting Files

Your teacher may collect or delete files from your handheld during a class session. For example, she may be collecting a homework assignment, or she may delete certain files prior to a test. When the teacher collects or deletes files, you receive a message on your handheld.

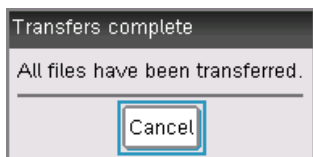

- ▶ Click **Cancel** to dismiss the message.



# Configuring Handhelds

This chapter provides information needed to:

- Maintain batteries used in the handheld.
- Change the default settings.

## ***Installing the AAA Batteries***

To install the batteries shipped with your handheld, complete the following steps.

1. Remove the keypad from the front of the handheld.
  - To unlock the keypad, turn the handheld over and slide the switch on the back of the handheld to the right.

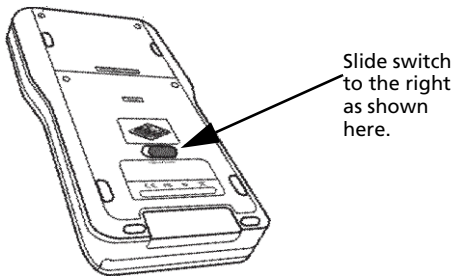

- Lift the keypad out.

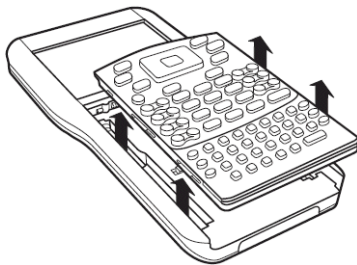

2. Insert the four alkaline AAA batteries provided with the handheld into the battery compartment. Arrange the batteries according to the polarity (+ and -) diagram.

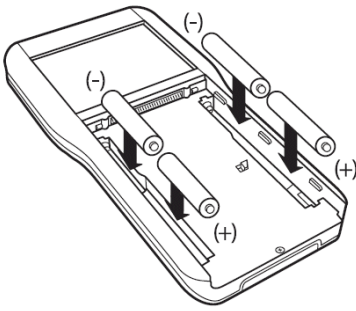

### 3. Replace the keypad.

- Align the keypad with the grooves as shown. Don't try to slide the keypad in from the bottom of the handheld. Place the keypad about an inch below the screen so that it fits into the grooves and lies flat.

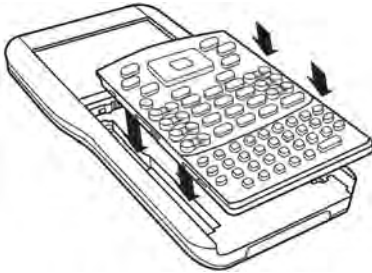

- Push the keypad firmly into place. You will hear a click and the switch on the back of the keypad is in the locked position.



## Replacing AAA Batteries

**Caution:** When removing the keypad to change AAA batteries, be certain that the handheld is completely powered down. Removing the keypad before the display is cleared may result in loss of data.

1. Save any open documents and turn off the handheld.
2. Remove the keypad from the handheld.
3. Carefully remove the batteries.

**Caution:** You may need to use a tool to remove the batteries as they fit tightly in the unit. If using a tool, be careful not to damage either the batteries or the handheld.

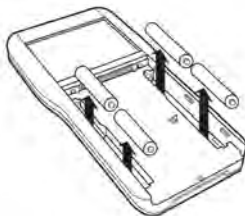

4. Insert fresh batteries.

Ensure that the + side of each battery faces away from the display screen.

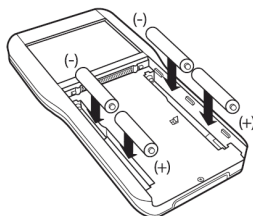

5. Replace the keypad.

## Inserting the TI-Nspire™ Rechargeable Battery

If purchased, complete the following steps to insert the TI-Nspire™ Rechargeable Battery into a handheld.

1. Use a small screwdriver to release the panel from the back of the handheld.

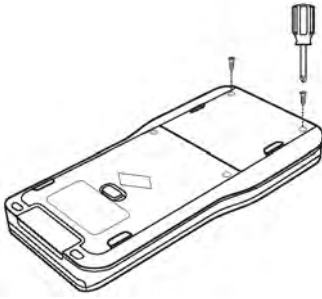

2. Remove the panel.

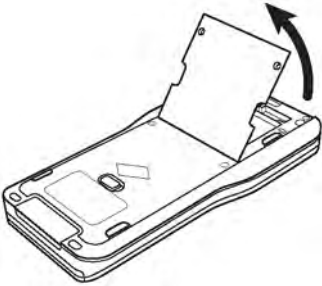

3. Insert the white connector into the jack, as shown.

**Note:** The red wire in the connector should face downward.

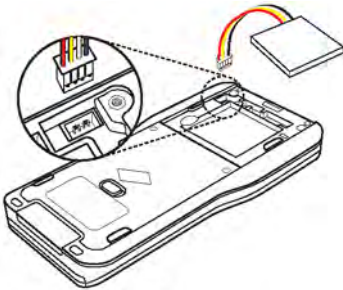

4. Thread the wire into the case to secure it. Insert the rechargeable battery into its compartment.

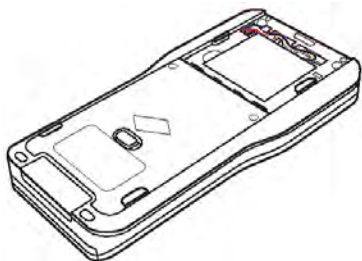

5. Replace the back panel and fasten the screws with a screwdriver.

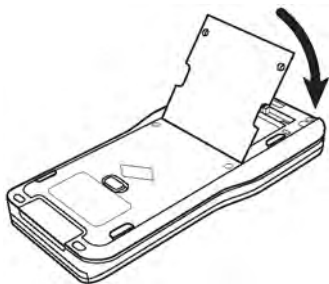

## Checking Battery Status

To check the status of both the TI-Nspire™ Rechargeable Battery and the AAA batteries in a handheld:

1. Press **(on)** to access the **Home** screen.
2. Press **(5)** **(4)** to open the **Handheld Status** window.

**Note:** From an open document, press **(doc v)** **(7)** **(4)**.

## Recharging the Handheld

To recharge the TI-Nspire™ Rechargeable Battery in a handheld, connect it to either of the following power sources:

- A standard USB cable connected to a computer
- A standard, TI USB wall charger (sold separately in Europe and Asia)

The amount of time required to fully charge the battery may vary, but charging normally takes about six hours. It is not necessary to remove the TI-Nspire™ Rechargeable Battery from the handheld to recharge it. The handheld operates normally while it is attached to a charging source.

## Recharging a Battery from a Computer

To recharge a handheld from a computer, a TI-Nspire™ USB driver must be installed. USB drivers are standard with any TI-Nspire™ software, which includes:

- TI-Nspire™ Teacher Software
- TI-Nspire™ CAS Teacher Software
- TI-Nspire™ Student Software
- TI-Nspire™ CAS Student Software
- TI-Nspire™ Navigator™ Teacher Software
- TI-Nspire™ CAS Navigator™ Teacher Software

To download software that includes a driver, go to [education.ti.com/software](http://education.ti.com/software).

## Understanding the Priority of Power Sources

After installing and charging the rechargeable battery, use the handheld with or without the AAA (non-rechargeable) batteries. The handheld draws power in the following order:

- First, from a connected external power source, such as:
  - A computer connected through a standard USB cable
  - A TI USB wall charger (sold separately in Europe and Asia)
- Second, from the TI-Nspire™ Rechargeable Battery (sold separately)
- Last, from the AAA (non-rechargeable) batteries

## Disposing of Used Batteries Safely and Properly

Do not mutilate, puncture, or dispose of batteries in fire. The batteries can burst or explode, releasing hazardous chemicals. Discard used batteries according to local regulations.

## Changing Handheld Settings

Use the options on the Settings menu to change or view the following settings:

- Change language
- Settings (General and Graphs & Geometry)
  - Define or restore settings for open documents and the Scratchpad
  - Define or restore default settings for the handheld
- Handheld Setup



- Status
- Login

**Note:** Not all options are accessible at all times. Options that are unavailable are dimmed.

## Opening the Settings Menu

- ▶ From the Home screen, press (5) or use the Touchpad to select **Settings**.

The Settings menu opens.

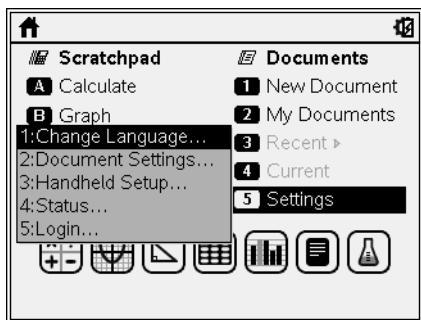

## Changing the Preferred Language

Complete the following steps to change the preferred language:

1. From the Home screen, press (5) or select **Settings** to open the menu.
2. From the menu, select **Change Language** or press (1).

The Change Language dialog box opens.

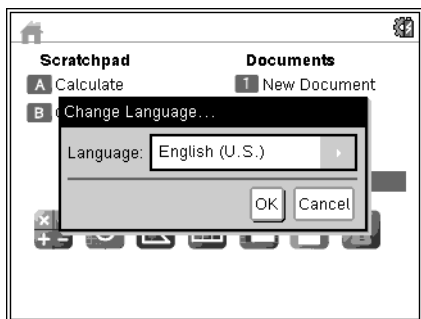

3. Press ▶ to open the drop-down list.

- Press **▼** to highlight a language, and then press **OK** or **enter** to select it.
- Press **tab** to highlight the **OK** button, and then press **OK** or **enter** to save the language selection.

## Customizing the Handheld Setup

Handheld setup options enable you to customize options to suit your needs.



- Font size (small, medium, or large).
- Power standby. (1, 3, 5, 10, or 30 minutes).
  - Use this option to extend battery life.
  - By default, the handheld automatically powers down after three minutes of inactivity.
- Hibernate (1, 2, 3, 4, 5 days, or never).
  - Use this option to extend battery life.
  - By default, the handheld hibernates after four days.
  - When hibernating, the handheld saves current work in memory.
  - When you turn the handheld on again, the system reboots and opens saved work.
- Pointer speed (slow, normal, or fast).
- Enable tapping to click.

## Changing Handheld Setup Options

- From the **Home** screen, press **5** **3** (**Settings > Handheld Setup**).

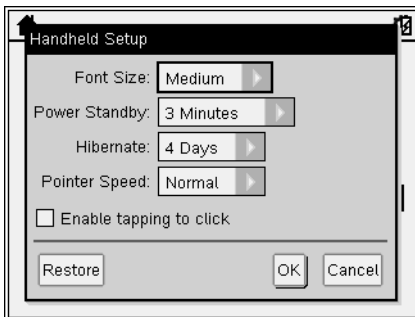
The Handheld Setup dialog box opens.



2. Press **tab** until the desired category is highlighted.
3. Press **▶** to view the list of possible settings.
4. Press **▼** to highlight the desired setting.
5. Press  or **enter** to select the new setting.
6. When you have changed all the settings to suit your needs, press **tab** until **OK** is highlighted, and then press  or **enter** to apply your changes.

**Note:** Click **Restore** to return the handheld to the factory settings.

**Note:** When operating in TI-84 mode, you cannot modify the power standby or hibernate options. TI-84 mode will follow the same power settings established within the TI-Nspire™ native mode.

## Customizing Document Settings

Document settings control how the handheld displays and interprets information in TI-Nspire™ documents and in Scratchpad. All numbers, including elements of matrices and lists are displayed according to the document settings. You can change the default settings at anytime and you can also specify settings for a particular document.

Document settings and their possible values are listed in the following table.

Field	Values
Display Digits	Float Float1 - Float12 Fix0 - Fix12
Angle	Radian Degree Gradian
Exponential Format	Normal Scientific Engineering
Real or Complex	Real Rectangular Polar

Field	Values
Calculation Mode	Auto CAS: Exact Approximate <b>Note:</b> Auto mode displays an answer that is not a whole number as a fraction except when a decimal is used in the problem. Exact mode (CAS) displays an answer that is not a whole number as a fraction or in symbolic form, except when a decimal is used in the problem.
Vector Format	Rectangular Cylindrical Spherical
Base	Decimal Hex Binary
Unit System (CAS)	SI Eng/US

## Changing Default Document Settings

Complete the following steps to define default document settings for TI-Nspire™ documents and Scratchpad.

1. Save and close any open documents.
2. From the Home screen, press **(5)** **(2)** (**Settings > Document Settings**).

The Document Settings dialog box opens.

**Note:** If a document is open, the Document Settings dialog box also contains an **OK** button. If you select **OK**, settings are only applied to the open document.

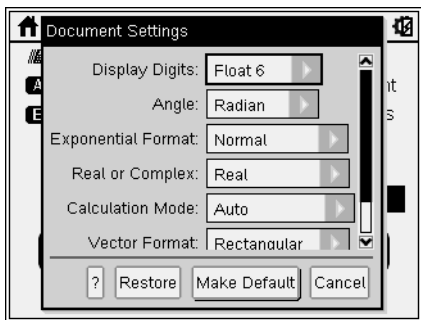

3. Press **(tab)** to move through the list of settings. Press **▲** to move backward through the list.

A bold line around a box indicates it is active.

4. Press **▶** to open the drop-down list to view the values for each setting.
5. Press the **▲** and **▼** keys to highlight the desired option, and then press **(F2)** or **(enter)** to select the value.
6. Select **Make Default**.

The Apply and Save as Default dialog box opens.



7. Click **OK** to save the settings as default settings that will be applied to all TI-Nspire™ documents and to Scratchpad.

## Changing Document Settings in a TI-Nspire™ Document

Complete the following steps to change document settings for an open TI-Nspire™ document. You can apply the settings to the current document only or choose to make the settings the default settings for the open document and all future documents.

1. From an open document, press **(fn on)** **(5)** **(2)** **(fn on)** > **Settings** > **Document Settings**).

The Document Settings dialog box opens.

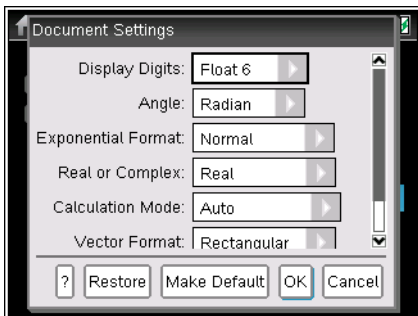

2. Press **(tab)** to move through the list of settings. Press **(up arrow)** to move backward through the list.  
A bold line around a box indicates it is active.
3. When you reach the desired setting, press **(right arrow)** to open the drop-down list to view values for each setting.
4. Press the **(up arrow)** and **(down arrow)** keys to highlight the desired option, and then press **(fn on)** or **(enter)** to select the value.
5. Click **OK** or press **(fn on)** or **(enter)** to apply the new settings to the open document.

The Home screen opens and the new settings are only applied to the open document.

To apply the new settings to the open document *and* to documents created in the future:

- Select **Make Default** and press **(fn on)** or **(enter)**.
- Click **OK** to apply the settings to any open documents and save the settings as defaults for new documents and for Scratchpad.

## Restoring Document Settings

Complete the following steps to restore the original factory settings to open or new documents and to the Scratchpad.

1. From the Home screen, press **(5)** **(2)** (**Settings** > **Document Settings**).

The Document Settings dialog box opens.

- Use the Touchpad or press **(tab)** to select **Restore**, and then press **(enter)**.

The Restore Defaults dialog box opens.

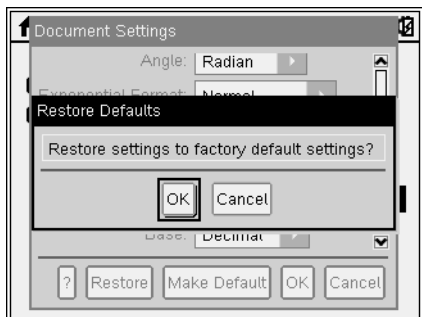

- Click **OK** to restore settings to the factory default settings.
- Press **OK** or **(esc)** to return to the **Home** screen.

## Customizing Graphs & Geometry Settings

Graphs & Geometry settings control how information is displayed in open problems and in subsequent new problems. When you customize application settings, your selections become the default settings for all of your work in the Graphs & Geometry application.

Complete the following steps to change the Graphs & Geometry Settings and make these settings the default for all new graphs and geometry documents and Scratchpad.

- Open a document with the Graphs or Geometry application active.
- Press **(menu)** **(9)** **(menu)** > **Settings**.

The Graphs & Geometry Settings dialog box opens.

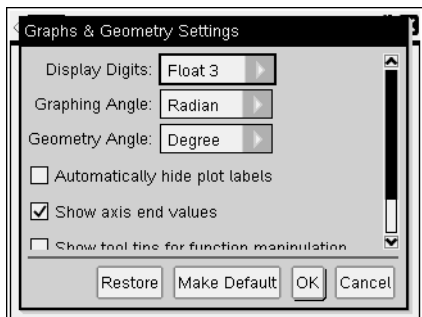

3. Press **(tab)** to move through the list of settings. Click **▶** to open the drop-down list to view the values for each setting.

<b>Field</b>	<b>Values</b>
Display Digits	Auto Float Float1 - Float12 Fix0 - Fix12
Graphing Angle	Auto Radian Degree Gradian
Geometry Angle	Auto Radian Degree Gradian

4. Press **▼** to view the values, and then press **(F1)** or **(enter)** to select a value.
5. In the lower half of the dialog, select a check box to enable an option or clear a check box to disable an option.

<b>Check box</b>	<b>Operation when selected</b>
Automatically hide plot labels	Plot labels display only when a plot is hovered, selected, or grabbed.
Show axis end values	Displays a numeric label at the least and greatest values visible on an axis.
Show tool tips for function manipulation	Shows helpful information as you manipulate function graphs.
Automatically find a point of interest	Shows zeros, minima, and maxima for graphed functions and objects while tracing function graphs.



- Choose one of the following options:
  - To apply the customized settings to ALL graphs and geometry documents, click **Make Default**. When the Apply and Save as Default dialog box opens, click **OK**.
  - To apply the settings to the open document only, click **OK**.
  - To restore default settings, click **Restore**. When the Restore Defaults dialog box opens, click **OK**.
  - Click **Cancel** to close the dialog box without making changes.

## Viewing Handheld Status

The **Handheld Status** screen provides the following information about the current state of the handheld:

- Status of the AAA and the rechargeable batteries
- Software version
- Available space
- Network (if any)
- Your student login name and whether you are logged in
- About

## Opening the Handheld Status Screen

- From the Home screen, press (5) (4) (**Settings > Status**).

The **Handheld Status** screen opens.

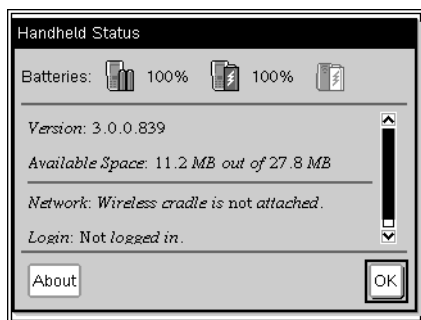

- Click **OK** to close the Handheld Status screen.

## Viewing Handheld Details

The About screen provides additional information about the handheld type, the operating system (OS) version, and the product ID.

1. From the Home screen, press **5** **4** (**Settings > Status**).  
The **Handheld Status** screen opens.
2. Click **About** to view details about the handheld.

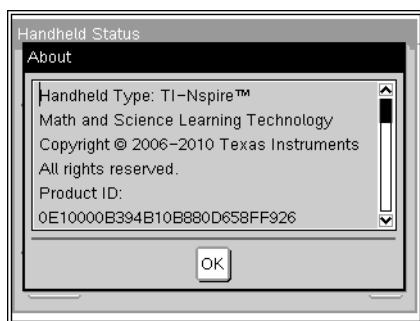

3. Click **OK** to close the **About** dialog box.
4. Click **OK** to return to the Home screen.

## ***Using Wireless Communication Hardware***

Teachers using TI-Nspire™ Navigator™ Teacher Software in the classroom can use TI-Nspire™ Navigator™ Cradles to establish a wireless connection between the teacher computer and any TI-Nspire™ handheld.

### **Attaching a Wireless Cradle to a Handheld**

The TI-Nspire™ Navigator™ Cradles can be used with all TI-Nspire™ handhelds to wirelessly connect to the teacher computer. To connect a handheld to a cradle:

1. Slide the lock on the back of the cradle to the OFF position.

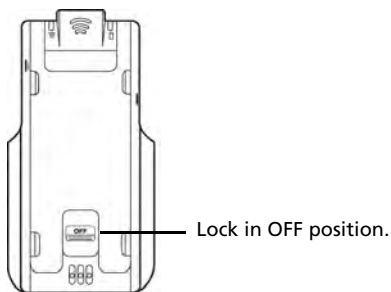

- To attach the handheld, face the screen upward and slide the handheld onto the top of the TI-Nspire™ Navigator™ wireless cradle. Be sure that both sides of the handheld are inserted into both of the side guides.

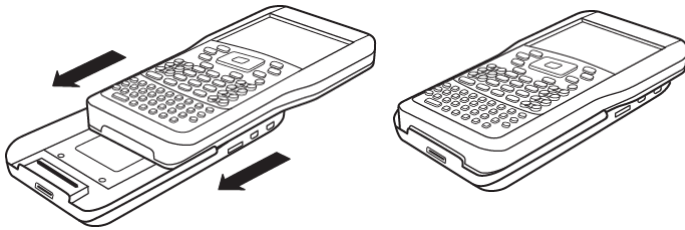

- Press firmly to make a good connection. When properly connected, the TI-Nspire™ handheld appears to be sitting on top of the cradle.
- Lock the handheld in place by sliding the lock on the back of the cradle to the ON position.

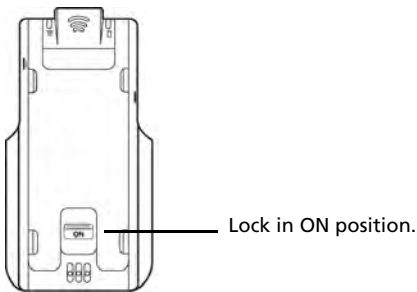



# Connecting Handhelds and Transferring Files

This chapter describes how to connect one TI-Nspire™ handheld to another, how to connect handhelds to a computer, and how to transfer files between them.

The TI-Nspire™ handhelds have a USB port that enables connectivity with another TI-Nspire™ handheld or with a computer.

**Note:** When using the TI-Nspire™ TI-84 Plus keypad, you can connect with another TI-Nspire™ handheld using the TI-Nspire™ TI-84 Plus keypad or a TI-84 Plus using the USB port or the I/O port.

## Connecting Handhelds

### Using USB Cables

You can use USB cables to connect two TI-Nspire™ handhelds, to connect a TI-Nspire™ handheld to a computer, or to connect one TI-Nspire™ handheld using TI-Nspire™ TI-84 Plus keypad to another.

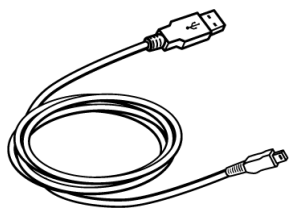

TI-Nspire™ USB connection cable to connect handheld to a computer.

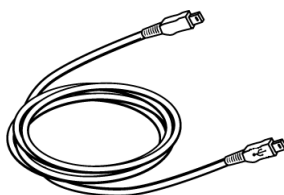

TI-Nspire™ handheld mini-USB cable to connect two TI-Nspire™ handhelds.

### Connecting Two TI-Nspire™ Handhelds with the Mini-USB Cable

You can connect two handhelds as long as both handhelds are using the same keypad. You cannot connect a handheld using the TI-Nspire™ TI-84 Plus keypad to a handheld using the native TI-Nspire™ keypad.

The TI-Nspire™ handheld USB port is located in the center on the top of the TI-Nspire™ handheld.

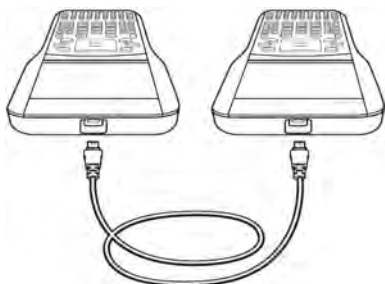

The USB port is located on the top of the TI-Nspire™ CX handheld on the right side when holding the handheld with the screen facing you.

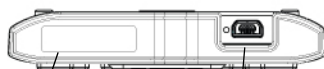

Port for connecting a wireless adapter

USB port on the CX handheld

To connect the handhelds:

1. Firmly insert either end of the mini-USB cable into the USB port.
2. Insert the other end of the cable into the receiving handheld's USB port.

## Connecting the TI-Nspire™ Handheld to a Computer

1. Firmly insert the mini-USB end of the cable into the port at the top of your handheld.



2. Firmly insert the USB end of the cable into the USB port of the computer.

## Transferring Files to and from Handhelds

You can send documents, Operating System (OS) files, and folders to another TI-Nspire™ handheld.

## Rules for Transferring Files and Folders



- You can transfer documents and OS files.
- Operating systems are not interchangeable between different handheld types. For example, you cannot transfer a CAS operating system to a non-CAS handheld.
- If a document with the same name as the one you are sending already exists on the receiving handheld, the document will be renamed. The system appends a number to the name to make it unique. For example, if Mydata existed on the receiving handheld, it would be renamed Mydata(2).



Both the sending and receiving handhelds will display a message that shows the new name.

- There is a 255-character maximum length for a file name, including the entire path. If a transmitted file has the same name as an existing file on the receiving handheld and the file names contain 255 characters, the name of the transmitted file will be truncated to enable the software to follow the renaming scheme described in the previous paragraph.
- All variables associated with the document being transmitted are transferred with the document.
- Transmissions will time out after 30 seconds.

**Caution:** Some older TI-Nspire™ handhelds cannot receive folders; only files. If you receive an error in sending to an older TI-Nspire™ handheld, see *Common error and notification messages*.

## Sending a Document or Folder to Another Handheld

1. Ensure the two handhelds are connected.
2. Open the My Documents file browser and navigate to the file or folder you want to transfer.
3. Press the ▲ and ▼ keys on the Touchpad to highlight the document or folder you want to send.
4. Press    to select **Send** from the Documents menu.

TI-Nspire™ handheld: Press   .

5. The file transfer begins. A progress bar shows the status of the transfer. There is also a cancel button in the Sending... dialog box to enable you to cancel the transmission while it is in progress.

At the end of a successful transmission, the message “<Folder / File name> transferred as <Folder / File name>.” is displayed. If the file had to be renamed on the receiving handheld, the message will show the new file name.

### Receiving a Document or Folder

No action is required by the user of the receiving TI-Nspire™ handheld. Handhelds are automatically powered on when the cable is attached.



At the end of a successful transmission, the message “<Folder / File name> received.” is displayed. If the file had to be renamed, the message will show the new file name.



**Caution:** Some older TI-Nspire™ handhelds cannot receive folders; only files. If you receive an error in sending to an older TI-Nspire™ handheld, see *Common error and notification messages*.

### Canceling a Transfer

1. To cancel a transmission in progress, press **Cancel** on the sending handheld. The user of either handheld can also press .

TI-Nspire™ handheld: press .

2. Press  or  to cancel the transmission error message.

TI-Nspire™ handheld: press  or .

## Transferring Files Between Computers and Handhelds

In the Documents Workspace, teachers and students can use the “drag and drop” method to quickly transfer files and folders from a computer to a handheld or transfer files from a handheld to a computer.

1. Connect the handheld to the computer using a standard A to mini-B USB cable.
2. In the TI-Nspire™ software, open the Documents Workspace.
3. In the Documents Toolbox, click  to open the Content Explorer.



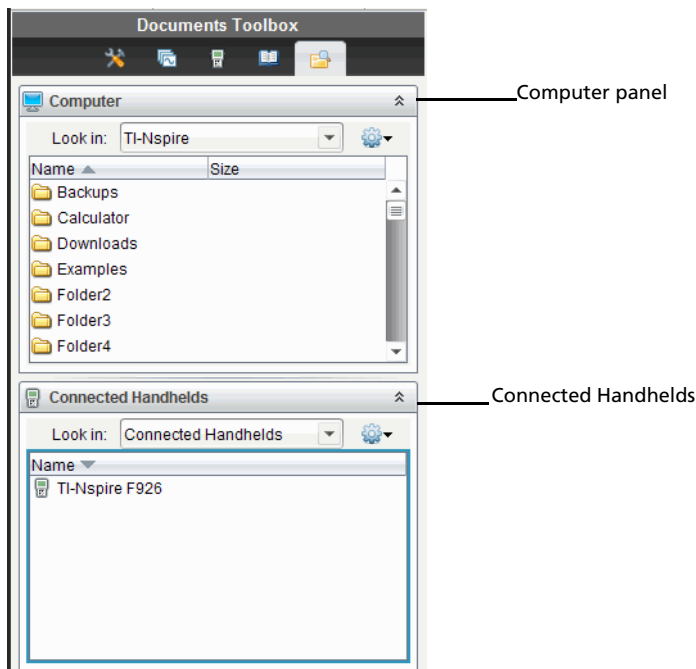

4. Navigate to the folder that contains the file you want to transfer.
  - To transfer a file from a handheld to the computer, click the file, and then drag the file to a folder in the Computer panel.
  - To transfer a file from the computer to a handheld, click the file, and then drag the file to a connected handheld.

**Note:** Those using the TI-Nspire™ Teacher Software or the TI-Nspire™ Navigator™ Teacher Software can also use options in the Content Workspace to transfer files from a handheld to a computer.

### Using the Save to Handheld Option

In the Documents Workspace, you can also use the Save to Handheld option on the File menu to transfer a file to a connected handheld when you want to save a file to a specific folder on the handheld.

1. Ensure the handheld is connected to the computer.
2. In the Computer panel, navigate to the folder where the file is located.
3. Click the file.

4. Click **File > Save to Handheld**. The Save to Handheld dialog box opens.

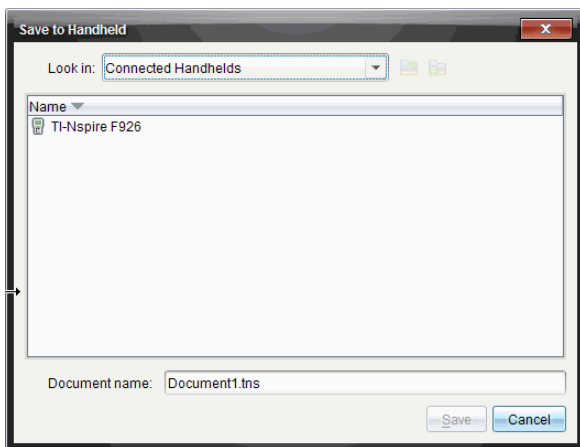

5. Double-click the handheld name, and then navigate to the folder where you want to save the file.
6. Click **Save**. The file is saved to the selected folder and the Save to Handheld dialog box closes.

## ***Handling Errors Resulting from Sending Folders***

If you receive an error after attempting to send a file, it may mean the receiving handheld has an operating system that does not support the transfer. To resolve this, update the receiving handheld's OS and try the send again.

## Common Error and Notification Messages

---

**Shown on****Message and Description**

---

Sending handheld

"This folder structure is not supported on the receiving handheld. The receiving handheld's OS may need to be updated, which you can do by selecting Send OS from the My Documents menu."

OK

If you get an error when sending a folder to an older TI-Nspire™ handheld, try updating the OS on the receiving handheld. If the error persists, you may have to send the files individually.

---

Sending handheld

"Transfer failed. Check cable and try again."

OK

This message is displayed if a cable is not attached to the sending handheld's link port. Remove and then reinsert the cable and try the document transmission again.

Click **OK** to cancel the transmission message.

**Note:** The sending handheld may not always display this message. Instead, it may remain BUSY until you cancel the transmission.

---

---

**Shown on****Message and Description**

---

Sending handheld

"Receiver does not have enough storage space for file transfer."

OK

This message indicates that the receiving handheld does not have enough memory to accept the file being transmitted.

The user of the receiving handheld must free space to obtain the new file. To do this:

- Delete unneeded files.
- Store files on a computer for later retrieval, and then delete them from the TI-Nspire™ handheld.

---

Sending handheld

"<folder>/<filename>  
transferred as  
<folder>/<filename(#)>."

This message is displayed at the end of a successful transfer when the file had to be renamed because a file already exists on the receiving handheld with the original name. The transmitted file is renamed by appending a number to the end of the name. Rename numbering always begins with (2) and can increment by one, as needed.

---

---

**Shown on****Message and Description**

---

Sending handheld

"<folder>/<filename>  
transferred as  
<folder>/<new filename>."

This message indicates that a new folder was created on the receiving handheld to contain the transmitted document.

---

Receiving handheld

"<folder>/<filename(x)>  
received."

This message indicates that the receiving handheld has a document with the same name as the document being sent.

---

Receiving handheld

"<new folder>/<new filename>  
received."

This message indicates that a new folder has been created to contain the transmitted document.

---

---

**Shown on****Message and Description**

---

Receiving  
handheld

“Transfer failed. Check cable  
and try again.”

OK

This message indicates that the cable is not correctly attached to the receiving handheld’s link port. Remove the cable then reattach it and try the transmission again.

Click **OK** to cancel the transmission message.

---

# Memory and File Management



The TI-Nspire™ Handheld comes equipped with 64 MB of memory. Of the total memory, 32 MB is dedicated to Flash storage and 32 MB is RAM. When the operating system is loaded, and as documents are created and stored on the handheld, memory is used and you may find that you need to free or restore memory after several months of use. If there is insufficient memory on the handheld, use one of the following options to restore space on the handheld:

- Delete documents and folders you no longer use.
- Back up files and folders to another handheld or computer.
- Reset the memory, which deletes ALL files and folders on the handheld.

## Checking Available Memory

Complete the following steps to view the amount of memory (in bytes) used by all documents and variables on your handheld.

1. From the Home screen, select **Status** from the **Settings** menu.

Press  **on**  .

The Handheld Status window opens.

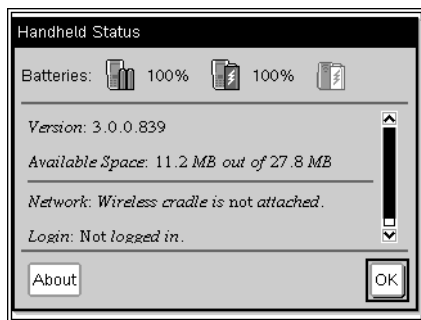

2. View the *Available Space* field to determine how much memory is available on the handheld.
3. Click **OK** to return to the Home screen.

## Freeing Memory

To free or recover memory, delete documents and/or folders from the handheld. To keep the documents and folders for later use, transfer them to another handheld or to a computer using the TI-Nspire™ software.

### Deleting Files from the Handheld

1. Press **(on)** **(2)** to open the **My Documents** file browser.
2. Press **▲** or **▼** to select the folder or document you want to delete.
3. Press **(del)**.

—or—

Press **(ctrl)** **(menu)** **(6)**.

A dialog box opens, asking you to confirm the deletion.

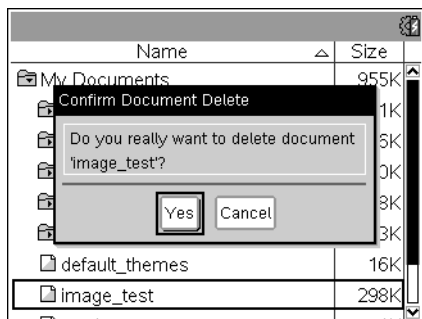

4. Press **(enter)** to confirm or **(esc)** to cancel.

The folder/document is permanently removed from the handheld.

### Backing up Files to Another Handheld

1. Connect the two handhelds using the USB-to-USB connectivity cable.
2. Press **(on)** **(2)** to open **My Documents** on the sending handheld.
3. Press the **▲** and **▼** keys to highlight the document you want to send.
4. Press **(menu)**, and then select Send.

—or—

Press **(ctrl)** **(menu)** **(2)**.

5. When the file transfer is complete, a message is displayed on the receiving handheld.



## Transferring Files to a Computer

Use the TI-Nspire™ software to transfer files and folders from a handheld to a computer.

1. Connect your handheld to the computer using a standard A to mini-B USB cable.
2. In the TI-Nspire™ software, open the Documents Workspace.
3. In the Documents Toolbox, click  to open the Content Explorer.

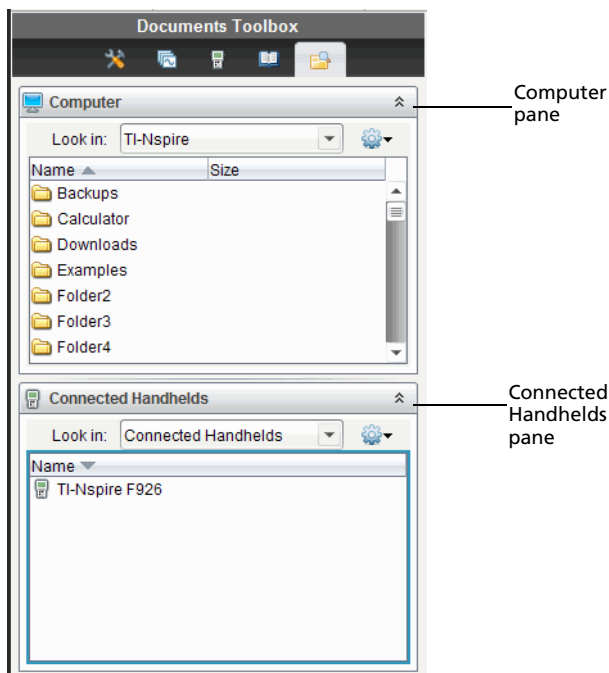

4. In the Computer pane, navigate to the folder in which you want to save the files.
5. In the Connected Handhelds pane, double-click the handheld name to view the folders and files on the handheld.

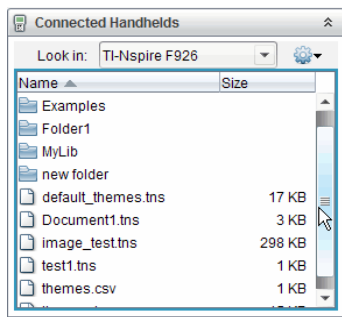

6. Select the file or folder you want to save to the computer.
  - Click the file to select one file or folder at a time.
  - To select all files on the handheld, select the first file in the list, hold down the **Shift** key, and then click the last file or folder in the list.
  - To select random files, click the first file, and then hold the **Ctrl** key while selecting additional files.

**Note:** If you select multiple files, it is saved as lesson bundle (.tilb file).

7. Drag the files to the folder in the Computer pane.

—or—

Select **File > Save as**.

The files are copied to the folder on the computer.

8. Verify that the files you need are available on your computer, and then delete the files from the handheld.

**Note:** Those using the TI-Nspire™ Teacher Software or the TI-Nspire™ Navigator™ Teacher Software can also use options in the Content Workspace to copy files from a handheld to a computer.

## ***Resetting the Memory***

Complete these steps only if you want to delete ALL files and folders on your handheld.

**Caution:** Before you reset all memory, consider restoring sufficient available memory by deleting only selected data. If you reset all memory, the pre-installed applications on your handheld will remain, but any applications that have been downloaded in TI-84 mode will be deleted.

1. After making certain you want to clear all files, press **( ON)** **(2)** to open the **My Documents** file browser.

2. Press **menu** to open the context menu.
3. Select **Delete All**.

—or—

Press **C**.

The Data Loss dialog box opens.

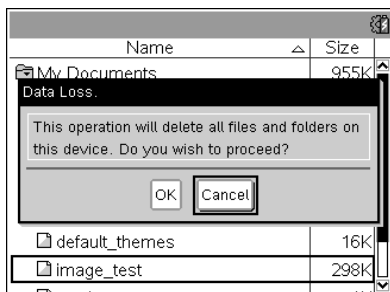

4. Click **OK** to confirm that you want to clear the handheld memory.



# Updating the Handheld Operating System

To take advantage of the latest handheld features and updates, download the latest operating system files from the Education Technology website (education.ti.com). You can update the operating system (OS) on TI-Nspire™ handhelds using a computer and the following software:

- TI-Nspire™ Teacher Software
- TI-Nspire™ Student Software
- TI-Nspire™ CAS Teacher Software
- TI-Nspire™ CAS Student Software
- TI-Nspire™ Teacher Navigator™ Software
- TI-Nspire™ CAS Teacher Navigator™ Software

In the classroom, you can use the TI-Nspire™ Docking Stations to upgrade the OS on multiple handhelds at the same time.

You can also transfer the OS from one TI-Nspire™ handheld to another or from one TI-Nspire™ CX handheld to another. However, handheld operating systems are not interchangeable. You cannot transfer a CAS operating system to a non-CAS handheld and you cannot transfer a TI-Nspire™ handheld operating system to a TI-Nspire™ CX handheld.



## ***What You Need to Know***

- If there is not enough room on the receiving handheld for the upgrade, a message is displayed. For more information, See *Memory and File Management*.
- OS upgrade operations do not delete user documents. The only time documents are affected by an OS installation is if the receiving handheld has a corrupted OS. In this situation, documents may be affected by OS restoration. It is a good practice to back up important documents and folders before installing an updated operating system.

**Warning:** Upgrading the operating system will delete all TI-84 applications and files. Before installing an OS upgrade, you should use TI Connect to back up all TI-84 applications and files to a computer. You can copy them back to the handheld when the OS upgrade is complete.

## ***Before You Begin***

Before beginning an OS download, ensure that batteries are at least 25 percent charged.

- To check the status of the rechargeable battery in TI-Nspire™ CX handhelds, press  on **5** **4** to open the **Handheld Status** dialog box.
- To check the status of both the rechargeable battery and the AAA batteries in TI-Nspire™ handhelds, press  on **5** **4** to open the **Handheld Status** dialog box.

When in OS download mode, the Automatic Power Down™ (APD™) feature does not function. If you leave your handheld in download mode for an extended time before you begin the downloading process, your batteries may become depleted. You will then need to replace or recharge the batteries before downloading the OS.

## ***Finding Operating System Updates***

For up-to-date information about available OS upgrades, check the Texas Instruments website at [education.ti.com](http://education.ti.com).

You can download an OS upgrade from the Texas Instruments website to a computer, and use a USB cable to install the OS on your TI-Nspire™ handheld. You will need an Internet connection and the appropriate USB cable to download the updates.

## **Checking for Handheld OS Updates**

When using TI-Nspire™ software, you can quickly determine if your handheld OS is up to date when the handheld is connected to a computer.

1. Open the TI-Nspire™ software and ensure the handheld is connected to your computer.
2. In the Documents Workspace, click  to open Content Explorer.
3. In the Connected Handhelds pane, select a connected handheld.

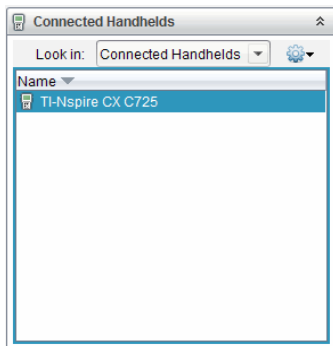

4. Select **Help > Check for Handheld OS Update**.
  - If the operating system is current, the Check for Handheld OS Update dialog box opens indicating that the operating system on the handheld is up to date.

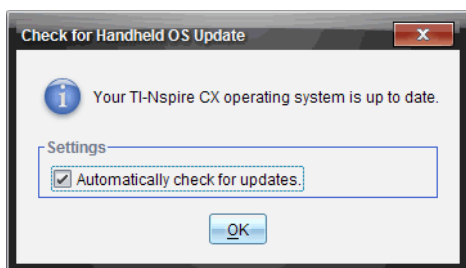



- If the operating system is not current, the dialog box contains a message indicating that a new version of the operating system is available.
5. To turn off automatic notifications, clear the "Automatically check for updates" check box. By default, this option is turned on.
  6. Click **OK** to close the dialog box.

## **Updating the Operating System**

In the TI-Nspire™ software, you can select to upgrade the operating system on a connected handheld from the following workspaces and menus:

- In all versions of the software, you can select **Help > Check for Handheld/Lab Cradle OS Update**. Select a connected handheld in the Content Explorer to activate this option. If the OS on the handheld is not current, the dialog box indicates that there is an updated version

of the operating system. Follow the prompts to update the operating system.

- In all versions of the TI-Nspire™ software, you can use options available in the Documents Workspace:
  - Open Content Explorer, select the handheld name, and then click  and select **Install OS**.
  - or—
  - Select **Tools > Install Handheld/Lab Cradle OS**.
- Those using teacher versions of the TI-Nspire™ software can use options available in the Content Workspace:
  - In the Resources pane, right-click the name of a connected handheld, and then select **Install Handheld/Lab Cradle OS**.
  - or—
  - Select the handheld name in the Preview pane, click  in the Preview pane, and then select **Install Handheld/Lab Cradle OS**.
  - or—
  - Right-click the handheld name and select **Install Handheld OS/Lab Cradle**.

## Completing the OS Upgrade

When you select to update the OS on a handheld, the Select Handheld OS File dialog box opens.

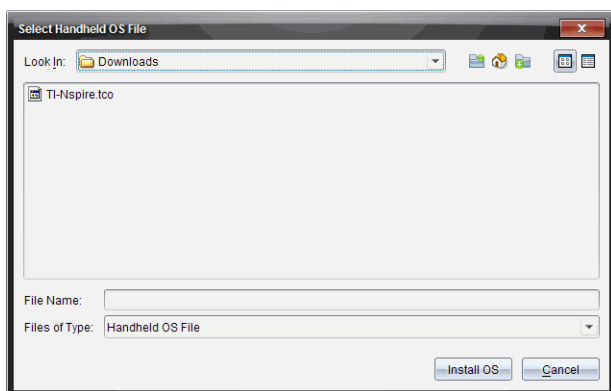

The file displayed for selection defaults to the file type required for the selected handheld.



1. Select the OS file:
  - If you are upgrading a TI-Nspire™ CX handheld, select TI-Nspire.tco
  - If you are upgrading a TI-Nspire™ CX CAS handheld, select TI-Nspire.tcc
  - If you are upgrading a TI-Nspire™ handheld, select TI-Nspire.tno
  - If you are upgrading a TI-Nspire™ CAS handheld, select TI-Nspire.tnc
2. Click **Install OS** to download the OS and update the handheld. The confirmation message *“You are about to upgrade your handheld operating system. Any unsaved data will be lost. Do you want to continue?”* is displayed.
3. Click **Yes** to continue.

The Installing OS dialog box opens indicating the progress of the download. Do not disconnect the handheld.



4. When the download is complete, the Information dialog box opens indicating that the OS file has been successfully transferred to the handheld. You can disconnect the handheld.

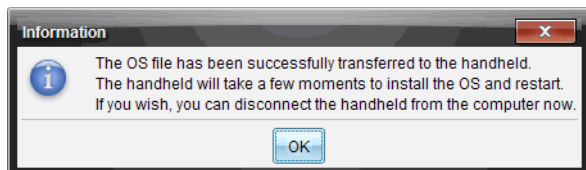

5. Click **OK**.

The updated operating system is installed on the handheld. When the update is complete, the handheld reboots.

- On the handheld, follow the prompts to:
  - Choose a preferred language.
  - Select a preferred font size.
- When the Welcome screen opens, click **OK**.

The Home screen opens.

## Transferring the Operating System From Another Handheld

**Note:** You cannot transfer the OS on a TI-Nspire™ handheld to a TI-Nspire™ CX handheld and you cannot transfer the OS on a CAS handheld to a non-CAS handheld. The operating systems are not the same and are not interchangeable.

To transfer the OS from one handheld to another:

- Ensure any open documents on the receiving handheld are closed.
- Connect the two handhelds using a USB mini-B to mini-B USB cable.
- On the sending handheld, select My Documents from the Home screen.
- Press , and then select **Send OS**.

On a TI-Nspire™ handheld, press .

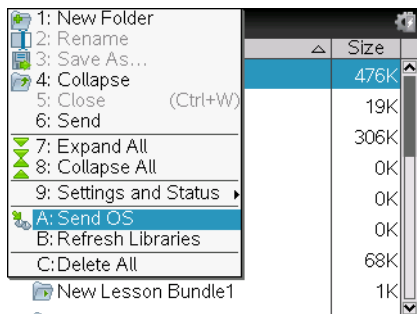

- On the receiving handheld, the message, "You are receiving an OS Upgrade. Unsaved changes will be lost. Would you like to continue?" is displayed along with Yes and No response buttons. Select Yes to receive the OS upgrade.
  - If **Yes** is not selected within 30 seconds, the handheld automatically responds with No, and the transmission is cancelled.

- It is important to save and close all open documents before performing an OS Upgrade. Continuing with an OS Upgrade on a handheld with an open, unsaved document will cause the loss of that data.
6. While the upgrade is in progress, the following messages are displayed on the receiving and sending handhelds:
    - *"Receiving OS. Do not unplug cable."*
    - *"Sending OS. Do not unplug cable."*
  7. After the transfer completes, the sending handheld receives a completion message and you can unhook the cable. The OS is automatically installed on the receiving handheld. During the installation process, the *"Installing OS <version number>"* message is displayed on the receiving handheld.
  8. When the installation is complete, the *"OS <version number> has been installed. Handheld will now restart."* message is displayed. The restart is initiated. If the sending handheld is still attached to the cable, the successful transmission message remains displayed on that handheld's screen.

**Important:**

- For each receiving handheld, remember to back up information as necessary and install new batteries.
- Be sure the sending handheld is on the **Send OS** screen.

## ***Updating the OS on Multiple Handhelds***

In the classroom, use the TI-Nspire™ Docking Station to upgrade the OS on multiple handhelds at the same time.

In the teacher versions of the TI-Nspire™ software, you can transfer files from the computer to multiple handhelds from the Content Workspace. See *Using the Content Workspace* for more information about transferring files to connected handhelds.

## OS Upgrade Messages

This section lists the information and error messages that can be displayed on handhelds during an OS Upgrade.

Shown on:	Message and Description
Sending handheld	<div data-bbox="329 283 702 506" style="border: 1px solid black; padding: 10px; text-align: center;"><p>“Receiver does not have enough storage space. Make &lt;xxxK&gt; available.”</p></div> <p data-bbox="326 529 918 713">This message indicates that the receiving handheld does not have enough memory available for the new OS. The space requirement is shown so you know how much memory must be cleared for the new operating system. Files can be moved to a computer for storage to free the necessary space.</p>
Sending handheld	<div data-bbox="329 730 702 931" style="border: 1px solid black; padding: 10px; text-align: center;"><p>“Receiver must change batteries before upgrading the OS.”</p></div> <p data-bbox="326 954 918 1050">This message indicates that the batteries in the receiving handheld need to be replaced. Send the OS Upgrade once the batteries are replaced.</p>
Sending handheld	<div data-bbox="329 1067 702 1270" style="border: 1px solid black; padding: 10px; text-align: center;"><p>“Receiver has a newer OS and cannot load this OS.”</p><p>OK</p></div> <p data-bbox="326 1293 918 1390">This message indicates that the receiving handheld has a newer OS version than the one being transmitted. You cannot downgrade an OS.</p>

---

**Shown on:****Message and Description**

---

Sending handheld

"Upgrade not accepted by receiver."

OK

This message indicates that the receiving handheld refuses the upgrade.

---

Sending handheld

"OS has been transferred.  
You can now unplug."

OK

This message indicates that the transfer is complete and it is safe to unplug the cable from the sending handheld.

---

Sending handheld

"Sending OS. Do not unplug cable."

This message, along with a progress bar, is displayed while the OS Upgrade is being transferred.

---

Both handhelds

"Transfer failed. Check cable and try again."

OK

The sending and/or receiving handheld is not properly connected. Reinsert the cable into each handheld, and then try the transmission again.

---

---

---

<b>Shown on:</b>	<b>Message and Description</b>
------------------	--------------------------------

---

Receiving handheld

"You are receiving an OS Upgrade. Unsaved changes will be lost. Would you like to continue?"

Yes                  No

This message is displayed when an OS Upgrade is about to begin. If you do not select Yes within 30 seconds, the system automatically responds with No.

---

Receiving handheld

"Receiving OS. Do not unplug cable."

This message, along with a progress bar, is displayed while the OS Upgrade is being transferred.

---

Receiving handheld

"Installing OS."

This message is displayed when the transfer is complete. It is shown to keep you informed of the handheld's status.

---

Receiving handheld

"OS has been installed. Handheld will restart."

OK

This information message displays briefly before the handheld automatically reboots.

---

---

**Shown on:****Message and Description**

---

Receiving  
handheld

"Install was corrupted.  
Handheld will reboot. You  
will need to retry OS  
upgrade."

OK

An error occurred during the transmission, and the installation was corrupted. The handheld will reboot. After the reboot, reinstall the OS Upgrade.

---





# Using Keyboard Shortcuts

## Keyboard Shortcuts

Use the following keyboard shortcuts to perform common functions. You can also perform all shortcuts performed by selecting options from menus.

---

### Getting Help

---

Open Hints



---

### Editing Text

---

Cut



Copy



Paste



Undo



Redo

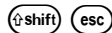

Toggle approximate and exact results



Change key to include appropriate accent



---

### Inserting Characters and Symbols in a document

---

Display character/symbol palette



Underscore



Display math template palette



Backslash (\)



Manual data capture point



Clear





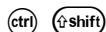















Caps Lock

















Store











Square brackets	 
Curly brackets	 
Display Trig symbol palette	
Equals symbol	
Display pi symbols palette ( $\pi$ , $\frac{1}{\theta}$ , $\theta$ , and so on),	
Display equality/inequality palette ( $>$ , $<$ , $\neq$ , $\leq$ , $\geq$ , and $ $ )	 
Display marks and letter symbols palette (? ! \$ ' " ; : _ \)	
Square root	 
log	 
ln	 
ans	 

## Managing Documents













Open document menu	
Open document	 
Close document	 
Create new document	 
Insert new page	 
Select application	 
Save current document	   

## Navigation













Top of page	 
End of page	 
Page Up	 

Page Down	 
Up a level in the hierarchy	 
Down a level in the hierarchy	 
Context menu for selection	
Extends selection in direction of arrow	 Any arrow







### Navigating in Documents

Displays previous page	 
Displays next page	 
Displays Page Sorter	 
Exits Page Sorter	 
Switch between applications on a split page	 
Moves focus backward within page	 



### Wizards and Templates











Add a column to a matrix after the current column	 
Add a row to a matrix after the current row	
Integration template	 
Derivative template	 
Math template palette	 or  
Fraction template	 

### Modifying Display

Increase contrast	 
Decrease contrast	 
Power off	 

### Using Application-Specific Shortcuts

Select all in Notes or Program Editor	 
---------------------------------------	---

Check syntax and store (in Program Editor)	 <b>B</b>
Insert Data Collection console	 <b>D</b>
Find (in Program Editor)	 <b>F</b>
Hide/Show Entry Line (in Graph or Geometry)	 <b>G</b>
Go To (in Lists & Spreadsheet, Program Editor)	
Find and Replace (In Program Editor)	 <b>H</b>
Insert math expression box (in Notes)	 <b>M</b>
Open the Scratchpad	
Recalculate (in Lists & Spreadsheet)	 <b>R</b>
Add Function Table (in Lists & Spreadsheet, Graph, and Geometry)	 <b>T</b>
Group/ungroup	 <b>4</b> /  <b>6</b>

## Working in TI-84 Mode

**Note:** The TI-Nspire™ CAS handheld does not operate in TI-84 mode. If the handheld is a CAS version, please disregard all references to operation in the TI-84 mode.

### ***Understanding Dual-Mode Operation***

The TI-Nspire™ handheld works with two keypads:

- The TI-Nspire™ keypad
- The TI-84 Plus keypad



TI-84 Plus keypad (on left)  
and TI-Nspire™ keypad (on the handheld)

### **Changing the Keypad**

**Caution:** When changing keypads, be certain that the handheld is completely powered down before removing the keypad. Removing the keypad before the display clears may result in loss of data.

1. Remove the cover and turn the handheld over. Slide the latch release to the right.

The keypad releases.

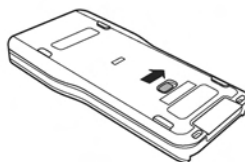

2. Turn the handheld top side up, and slide the keypad away from the display screen.



3. Lift the keypad off the handheld.

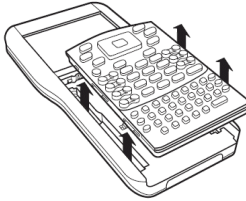

4. Insert the other keypad.

Ensure that it fits comfortably into the guides on the bottom and sides of the handheld.



**Note:** The keypad does not slide in from the bottom edge of the handheld. Instead, fit it into the guides just above the batteries.

5. When the keypad is properly seated on the handheld, push the keypad toward the display screen.

The keypad clicks into place when properly seated and completely inserted into the handheld.



## TI-84 Plus Mode Cables

If you already have TI-84 Plus handhelds and use the I/O port for connectivity, use the same cables to connect to a TI-Nspire™ handheld using the TI-84 keypad.

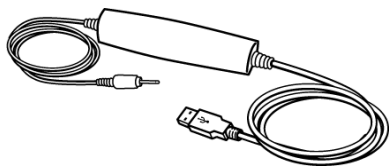

USB connection cable to connect handheld in TI-84 mode to a computer using TI-Connect software.

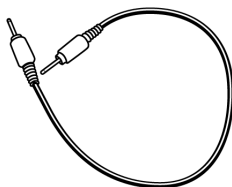

TI-84 Plus I/O handheld-to-handheld connection cable

## Connecting a TI-Nspire™ with TI-84 Plus Keypad to a TI-84 Plus Handheld

The TI-Nspire™ TI-84 Plus keypad I/O link port is located at the bottom edge of the keypad. The TI-84 Plus I/O link port is located at the top left edge of the calculator.

1. Firmly insert either end of the I/O cable into the port.
2. Insert the other end of the cable into the other handheld's I/O port.

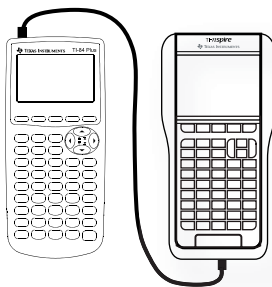

## Capturing Screens in TI-84 Mode

To capture screens when using a TI-Nspire™ TI-84 Plus handheld, you must use TI Connect™ Software. TI Connect™ Software is available for both Windows® and Mac® systems and includes options for capturing screen images, transferring files, and updating operating systems. For more information about TI Connect™ Software, visit the [education.ti.com](http://education.ti.com) website.

## ***Upgrading the TI-84 Plus OS***

To update the operating system on a TI-84 Plus handheld using TI-Nspire™ software, switch to the TI-Nspire™ faceplate and install the latest OS available from TI.



## **Appendix: Service and Support**

### ***Battery Precautions***

Take these precautions when replacing batteries.

- Do not leave batteries within the reach of children.
- Do not mix new and used batteries.
- Do not mix brands (or types within brands) of batteries. There is a risk of explosion if a battery is replaced by the wrong type.
- Do not under any circumstances use rechargeable AAA batteries in your handheld.
- Install batteries according to polarity (+ and - ) diagrams.
- Properly dispose of used batteries immediately.
- Do not incinerate or dismantle batteries.

### **Disposing of Batteries**

Do not mutilate, puncture, or dispose of batteries in fire. The batteries can burst or explode, releasing hazardous chemicals. Discard used batteries according to local regulations.

## ***Texas Instruments Support and Service***

### **For U.S. and Canada:**

#### **For General Information**

**Home Page:** [education.ti.com](http://education.ti.com)

**KnowledgeBase and e-mail inquiries:** [education.ti.com/support](http://education.ti.com/support)

**Phone:** (800) TI-CARES / (800) 842-2737  
For U.S., Canada, Mexico, Puerto Rico, and Virgin Islands only

**International information:** [education.ti.com/international](http://education.ti.com/international)

#### **For Technical Support**

#### **For Product (Hardware) Service**

**Customers in the U.S., Canada, Mexico, Puerto Rico and Virgin Islands:** Always contact Texas Instruments Customer Support before returning a product for service.

#### **For All Other Countries:**

For general information

For more information about TI products and services, contact TI by e-mail or visit the TI Internet address.

**E-mail inquiries:** [ti-cares@ti.com](mailto:ti-cares@ti.com)

**Home Page:** [education.ti.com](http://education.ti.com)

#### ***Service and Warranty Information***

For information about the length and terms of the warranty or about product service, refer to the warranty statement enclosed with this product or contact your local Texas Instruments retailer/distributor.

# Index

## A

- AAA batteries 3
  - installing 61
  - replacing 63
- About CAS 1
- adding
  - accents to text 50
  - applications 30
  - images 53
  - multiple applications to pages 31
  - pages to problems 42
  - problems 42
- adjusting contrast 7
- APD™ 3
- Application icons 7
- applications
  - adding to documents 30
  - Calculator 8
  - Data & Statistics 8
  - Geometry 8
  - Graphs 8
  - Lists & Spreadsheet 8
  - multiple on pages 31
  - Notes 8
  - swapping 34
  - Vernier DataQuest 8
- arrow keys 5
- Automatic Power Down™ 3
- available memory 89

## B

- backup
  - handheld files to another handheld 90
- batteries
  - AAA 3
  - disposing of 66
  - installing 61
  - rechargeable 3, 63
  - replacing 63
  - TI-Nspire/TM Rechargeable Battery 63
- battery status 65
- browsing files 44

## C

- cables
  - TI-84 Plus Mode 113
- cables, USB 79
- Calculate 7
- Calculator 8
- Calculator history
  - viewing 17
- canceling, file transfers 82
- Capturing screens in TI-84 mode 113
- CAS 1
- CAS handhelds 1
- Catalog 13
  - inserting commands 48
  - inserting items from 13, 15
  - opening 47
  - wizards 49
- changing
  - Graphs & Geometry Settings 73
- characters
  - international language 50
  - special 49
- Checking battery status 65
- Choosing a font size 4
- class
  - logging in 57
- clearing
  - the Calculator history 18
- closing
  - documents 47
- communication hardware 76
- Computer Algebra System (CAS) 1
- computer touchpad 5
- connecting
  - handhelds to computers 80
  - two handhelds 79, 80
- contrast
  - adjusting 7
- copying
  - documents 47
  - folders 47
  - items from Calculator history 18
- copying images 53
- copyright statement *ii*

- creating
  - documents 28
  - folders 45
- customizing
  - Graphs & Geometry Settings 73
- customizing general settings 69

## **D**

- Data & Statistics 8
- default settings
  - restoring 72
- deleting
  - documents 46
  - folders 46
  - images 55
- deleting files 90
- disposing of batteries 66
- documents
  - closing 47
  - copying 47
  - copying pages to 40
  - creating 28
  - deleting 46, 90
  - managing 43
  - navigating 43
  - receiving 82
  - renaming 45
  - saving 29
  - sending to handhelds 81
  - structure 27
  - transferring 80
- downloading OS files 95

## **E**

- editing
  - math expressions 18
- entering math expressions 12
- error messages 102
  - file transfers 85
  - sending folders 84
- evaluating
  - math expressions 12
- evaluating a math expression 14
- expressions
  - copying from Calculator history 18
  - editing 18

- entering and evaluating 12
- entering from a template 14
- entering with a wizard 15
- selecting in Calculator 19

## **F**

- files
  - backing up 90
  - canceling transfers 82
  - deleting 90
  - naming conventions 46
  - saving to handhelds 83
  - transferring 80, 82
  - transferring to a computer 91
  - transferring to another handheld 81
- first time use 3
- folders
  - copying 47
  - creating 45
  - deleting 46
  - naming conventions 46
  - renaming 45
  - sending to handhelds 81
- font
  - choosing 4
  - size 4
- Freeing memory 90

## **G**

- General Settings
  - restoring 72
- General settings 69
- Geometry 8
- Graph 7
- Graphs 8
- Graphs & Geometry Settings
  - changing 73
  - customizing 73
  - viewing 73
- Graphs & Geometry settings 73

## **H**

- handheld
  - adjusting contrast 7
  - connecting to a TI-84 113

- first time use 3
- hints 10
- home menu 9
- home screen 6
- keys 2
- screen 9
- turning on for the first time 3
- hardware
  - communication 76
- hints 10
- history
  - deleting Calculator history 18
  - viewing Calculator 17
- history, Calculator
  - copying from 18
- Home screen 5
- home screen 6
  - options 6
- Home screen options 7

## I

- icons
  - application 7
- images
  - adding 53
  - copying 53
  - deleting 55
  - repositioning 54
  - resizing 55
- inserting items from the Catalog 13
- international language characters 50
- items
  - insert from catalog 13

## K

- keypad 2
  - changing 111

## L

- language
  - changing 67
  - choosing 3
  - international characters 50
- Lists & Spreadsheet 8
- logging in to class 57

## M

- math expressions 50
  - editing 18
  - entering and evaluating 12
  - selecting in Calculator 19
- math templates 49
- memory
  - checking 89
  - recovering 90
  - resetting 92
- menus
  - application 35
  - context 37
- mouse pointer 6
- moving, images 54
- My Documents 7, 44

## N

- naming files and folders 46
- New Document 7
- Notes 8

## O

- opening
  - Catalog 47
  - context menus 37
  - My Documents 44
- opening the Settings menu 67
- operating system
  - downloading files 95
  - finding updates 96
  - transferring 100
  - updating 95, 97
- options
  - Home screen 6, 7

## P

- page layouts
  - choosing 32
  - custom 33
- page sorter 38, 43
- pages 27
  - adding to problems 42
  - copying to another document 40
  - copying to another problem 40
  - reordering 38, 43

- reordering in problems 39, 40
- power sources 66
- preferred language 3, 67
- Preparing the handheld for use 3
- priority of power sources 66
- problems 27
  - adding pages 42
  - adding to pages 37
  - copying 41
  - copying pages to other problems 40
  - deleting 42
  - pasting 41
  - renaming 42
  - reordering 39

## R

- receiving
  - documents 82
  - folders 82
- rechargeable battery 3
- recharging
  - handhelds 65
  - TI-Nspire/TM Rechargeable Battery 65
- recovering deleted documents 47
- recovering memory 90
- removing images 55
- renaming
  - documents 45
  - folders 45
  - problems 42
- repositioning images 54
- resetting memory 92
- resizing images 55
- restoring general settings 72
- results
  - copying from Calculator history 18
- reusing
  - items from Calculator history 18

## S

- saving
  - documents 29
  - files to handhelds 83
- saving Scratchpad contents 24

- Scratchpad 7, 9
  - Calculate 7
  - Graph 7
  - saving 24
- selecting
  - expressions in Calculator 19
- selecting a language 3
- selecting images 53
- Selecting options 6
- setting
  - Graphs & Geometry 73
- Settings 7
- settings
  - General 69
- Settings & Status
  - Graphs & Geometry 73
- Settings menu 67
- software
  - upgrading 58

## T

- templates 49
  - math expressions 50
  - using 14
- TI-84
  - connecting to a TI-Nspire™ handheld 113
  - power options 69
- TI-84 mode
  - capturing screens 113
- TI-84 Plus keypad 111
- TI-84 Plus Mode cables 113
- TI-Nspire™ handhelds 1
- TI-Nspire™ Rechargeable Battery 3
- touchpad
  - using 5
- transferring
  - documents 80
  - files from a computer 82
  - files to a computer 82
  - files to another handheld 81
  - OS from another handheld 100
  - rules 81
- Transferring files to a computer 91

## U

- Understanding the Scratchpad 9

- updating handheld OS
  - before you begin 95
  - completing the update 98
  - multiple handhelds 101

## USB

- cables 79
- using the touchpad 5

## V

- variables 47
- Vernier DataQuest 8
- viewing
  - Graphs & Geometry Settings 73

## W

- Welcome! screen 5
- wireless communication hardware
  - 76
- wizard
  - entering expressions with 15
- wizards 49
- work areas 27, 31

